

BASE

“

It makes life so much easier. I was able to organize so much better, and it's so easy to access things now. No more getting down on the floor to reach things. For an older person, this is a must have!

- Mamma R

Innovation through *Organization*™

Most of our organizational solutions are designed for base cabinet applications, so you always have a versatile list of innovative products to choose from. From face frame to full access, rest assured we have the perfect product sized for your type of cabinet. These popular base cabinet accessories are designed with the same superior quality you have come to expect from Rev-A-Shelf.

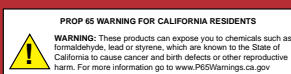



SCAN FOR PRICING!



- Natural maple construction with semi-gloss finish
- Full-extension, BLUM soft-close undermount slides
- Patented mounting straps (US Patent No. 9,756,941)
- Adjustable rub bushings
- Patented door mount brackets with 5" of adjustability and micro-trim adjuster (US Patent No. 8,388,076)
- Refillable paper towel holder
- SERVO-DRIVE technology available (sold separately)
- TSCA Title VI Compliant



448PTH-BCSC-8C



448PTH-BCSC-6C
Paper Towel Pullout
(6" version shown)



For video visit:
rev-a-shelf.com/videos

Paper Towel Pullout

PRODUCT	DESCRIPTION	DIMS	MCO	CAB	FINISH	SLP
448PTH-BCSC-6C	Paper Towel Pullout	6-7/8" (175 mm) W x 21-3/4" (551 mm) D x 26-29/32" (684 mm) H	FF: 6-5/8" (168 mm) FL: 7-1/8" (181 mm)	FHB9 FLFHB12	Maple	\$441.65
448PTH-BCSC-8C	Paper Towel Pullout	8-3/4" (222 mm) W x 21-3/4" (551 mm) D x 26-29/32" (684 mm) H	FF: 8-1/2" (216 mm) FL: 9" (229 mm)	FHB12	Maple	\$523.45



Two-Tier Cookware Organizer

4CW2 Series

SCAN FOR PRICING!



- Designed for 18" and 24" base cabinets
- Natural maple dovetail construction with semi-gloss finish
- Full-extension with 3/4" over-travel, undermount slides with BLUM MOVENTO soft-close
- Up to (220) pre-drilled peg holes
- (4) matching, press-in pegs
- Top shelf holds (1) lid organizer for 18" and (2) lid organizers for 24"
- Mounts to cabinet floor
- TSCA Title VI compliant

4CW2-24SC-1



4CW2-18SC-1
Maple Cookware Organizer



Customizable



For video visit:
rev-a-shelf.com/videos

Wood Two-Tier Base Organizer Pullout

PRODUCT	DESCRIPTION	DIMS	MCO	CAB	FINISH	SLP
4CW2-18SC-1	Cookware Organizer	14-1/2" (368 mm) W x 22-1/4" (565 mm) D x 18-7/8" (479 mm) H	14-1/2" (368 mm)	B18	Maple	\$679.05
4CW2-24SC-1	Cookware Organizer	20-1/2" (521 mm) W x 22-1/4" (565 mm) D x 18-7/8" (479 mm) H	20-1/2" (521 mm)	B24	Maple	\$812.00



SCAN FOR PRICING!



GLD-W22-BC-7



- Designed for 14" to 22" cabinet depths
- Solid wood construction, natural maple or gray w/ up to (7) Nickel Chrome hooks
- Mounts to cabinet top and rear
- (3) slide configurations:
 - Full-extension, ball-bearing, 100 lb. rated slides
 - Full-extension, BLUM soft-close undermount slides
 - Stainless steel full-extension, ball-bearing, 100 lb. rated slides
- US Patent No. 9,433,283 and 9,022,237
- TSCA Title VI compliant



For video visit:
rev-a-shelf.com/videos

NOTE: Dimensions are without the optional rear mounting bracket. Rear mounting bracket is 6-1/4" (159 mm) wide and adds 3/4" (19 mm) to the depth, and 13/16" (20 mm) to the height.

MCO dimensions and CAB recommendations are dependent on what accessories you intend on hanging on product. Typical cookware will fit in B18.

Waste

Blind Corner

Sink

Base

Tall

Drawer

Wall

Vanity

Closet

Lazy Susan

LED Lighting



SCAN FOR PRICING!



GLD-W14-SC-5
 Glideware™ Pullout
 w/ Ball-Bearing slide
 and (5) Hooks
 (14" version shown)



Closet application



GLD-W22-BG-7
 Glideware™ Pullout
 w/ BLUMOTION Soft-Close
 and (7) Hooks
 (22" version shown)



Use our B2B hooks for added storage anywhere you need



GLD-HK-L-NC-7
 Glideware™ Long Hook
 Nickel Chrome



GLD-HK-S-NC-7
 Glideware™ Short Hook
 Nickel Chrome



GLD-HK-2-NC-5
 Glideware™ Back-to-Back Hook
 Nickel Chrome

Glideware™ Pullout w/ (5 or 7) Short Hooks

PRODUCT	DESCRIPTION	DIMS	CAB	FINISH	SLP
GLD-W14-SC-5	14" Glideware™	4" (102 mm) W x 14" (356 mm) D x 4-1/8" (105 mm) H	FHB18	Maple	\$152.85
GLD-W22-SC-7	22" Glideware™	4" (102 mm) W x 22" (559 mm) D x 4-1/8" (105 mm) H	FHB18	Maple	\$188.20

Glideware™ Pullout w/ BLUMOTION Soft-Close and (5 or 7) Long Hooks

GLD-W14-BC-5	14" Glideware™	6" (152 mm) W x 14" (356 mm) D x 5-1/16" (129 mm) H	FHB18	Maple	\$261.60
GLD-W16-BC-5	16" Glideware™	6" (152 mm) W x 16" (406 mm) D x 5-1/16" (129 mm) H	FHB18	Maple	\$268.55
GLD-W22-BC-7	22" Glideware™	6" (152 mm) W x 22" (559 mm) D x 5-1/16" (129 mm) H	FHB18	Maple	\$405.40
GLD-W22-BG-7	22" Glideware™	6" (152 mm) W x 22" (559 mm) D x 5-1/16" (129 mm) H	FHB18	Gray	\$405.40

Glideware™ Accessories

GLD-HK-S-NC-7	(7) Glideware™ Short Hooks	1" (25 mm) W x 1-1/2" (38 mm) x 3-1/8" (80 mm) H		Nickel	\$14.35
GLD-HK-L-NC-7	(7) Glideware™ Long Hooks	1" (25 mm) W x 1-1/2" (38 mm) x 4" (102 mm) H		Nickel	\$17.85
GLD-HK-2-NC-5	(5) Glideware™ Back-to-Back Hooks	1" (25 mm) W x 2-43/64" (68 mm) x 3-1/8" (80 mm) H		Nickel	\$19.70



SCAN FOR PRICING!

Waste
Blind Corner
Sink
Base
Tall
Drawer
Wall
Vanity
Closet
Lazy Susan
LED Lighting

- Available in 10" height
- Chrome-plated round wire
- Mounts to cabinet floor
- Easy 4-screw installation
- Use multiple to create custom storage space

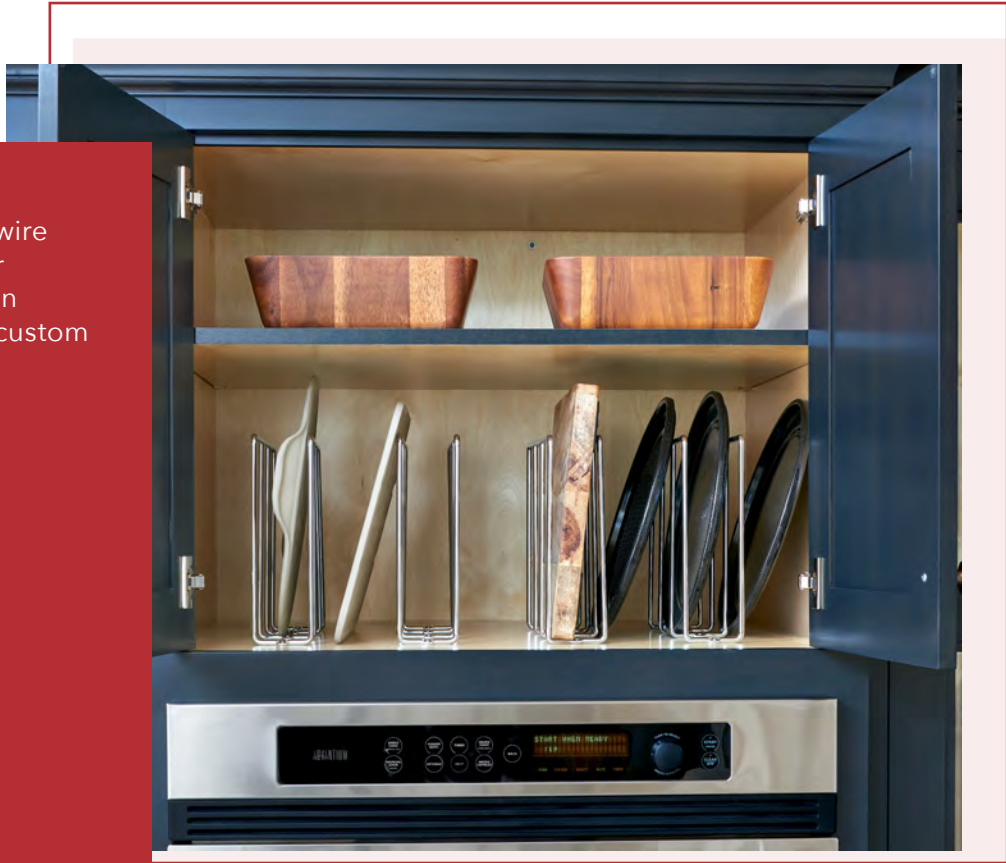

Simple bottom mount installation

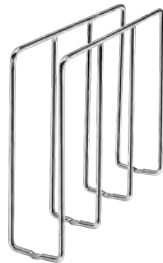

596-10CR-52
U-Shaped Tray Organizer

Chrome Wire U-Shaped Tray Organizer

PRODUCT	DESCRIPTION	DIMS	FINISH	SLP
596-10CR-52	U-Shaped Tray Divider	3" (76 mm) W x 11-7/8" (302 mm) D x 10" (254 mm) H	Chrome	\$27.25



Tray Divider w/ Clips

597 Series

SCAN FOR PRICING!



- Available in 12" and 18" height
- Chrome-plated or powder-coated white round wire
- Mounts to cabinet floor and rear wall
- Includes (4) screw-in clips and fasteners each
- Use multiple to create custom storage space

597-18-52

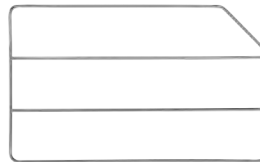

597-12CR-52
Tray Divider
(Chrome finish shown)

White Wire Tray Divider

PRODUCT	DESCRIPTION	DIMS	FINISH	SLP
597-12-52	Tray Divider with Clips	3/4" (19 mm) W x 20" (508 mm) D x 12" (305 mm) H	White Wire	\$14.80
597-18-52	Tray Divider with Clips	3/4" (19 mm) W x 20" (508 mm) D x 18" (457 mm) H	White Wire	\$17.40

(10) White Wire Tray Dividers

597-12-10	(10) 12" Tray Dividers with Clips	3/4" (19 mm) W x 20" (508 mm) D x 12" (305 mm) H	White Wire	\$10.75
597-18-10	(10) 18" Tray Dividers with Clips	3/4" (19 mm) W x 20" (508 mm) D x 18" (457 mm) H	White Wire	\$13.35

Chrome Wire Tray Divider

597-12CR-52	Tray Divider with Clips	3/4" (19 mm) W x 20" (508 mm) D x 12" (305 mm) H	Chrome Wire	\$17.85
597-18CR-52	Tray Divider with Clips	3/4" (19 mm) W x 20" (508 mm) D x 18" (457 mm) H	Chrome Wire	\$20.60

(10) Chrome Wire Tray Dividers

597-12CR-10	(10) 12" Tray Dividers with Clips	3/4" (19 mm) W x 20" (508 mm) D x 12" (305 mm) H	Chrome Wire	\$14.35
597-18CR-10	(10) 18" Tray Dividers with Clips	3/4" (19 mm) W x 20" (508 mm) D x 18" (457 mm) H	Chrome Wire	\$16.55

Waste
Blind Corner
Sink
Base
Tall
Drawer
Wall
Vanity
Closet
Susan
Lazy
LED Lighting



SCAN FOR PRICING!

Waste
Blind Corner
Sink
Base
Tall
Drawer
Wall
Vanity
Closet
Lazy Susan
LED Lighting

- Available in 12" and 18" height
- Chrome-plated round wire
- Mounts to cabinet floor and rear wall
- Use multiple to create custom storage space



LD-597-18CR-1

Chrome Wire Tray Divider

PRODUCT	DESCRIPTION	DIMS	FINISH	SLP
LD-597-12CR-1	12" Chrome Tray Divider	1/4" (6 mm) W x 20" (508 mm) D x 12" (305 mm) H	Chrome	\$20.45
LD-597-18CR-1	18" Chrome Tray Divider	1/4" (6 mm) W x 20" (508 mm) D x 18" (458 mm) H	Chrome	\$23.20
(10) Chrome Wire Tray Dividers				
LD-597-12CR-10	(10) 12" Chrome Tray Dividers	1/4" (6 mm) W x 20" (508 mm) D x 12" (305 mm) H	Chrome	\$16.40 ea.
LD-597-18CR-10	(10) 18" Chrome Tray Dividers	1/4" (6 mm) W x 20" (508 mm) D x 18" (458 mm) H	Chrome	\$19.15 ea.



Two-Tier Base Organizer

548 Series

SCAN FOR PRICING!



- Designed for 9" base cabinets
- Ball-bearing slides
- Universal brackets for right or left hand mounting
- Door mountable chrome frame

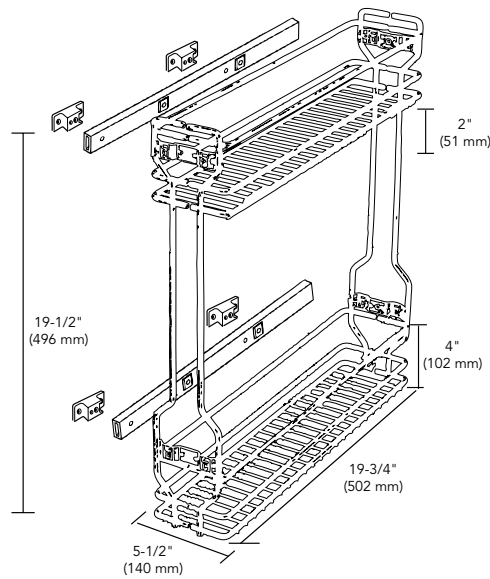

Chrome Two-Tier Base Organizer Pullout

PRODUCT	DESCRIPTION	DIMS	MCO	CAB	FINISH	SLP
548-06CR-1	Base Organizer	5-1/2" (140 mm) W x 19-3/4" (502 mm) D x 19-1/2" (495 mm) H	6" (152 mm)	B9	Chrome	\$155.75

Waste
Blind Corner
Sink
Base
Tall
Drawer
Wall
Vanity
Closet
Susan
Lazy
LED Lighting



SCAN FOR PRICING!



5WB2-1822CR-1

5WB1

- Designed for 12", 15", 18", 21", 24" and 27" base cabinets
- Chrome-plated round wire frame ideal for organizing bulky items
- Full-extension, ball-bearing slides available in 18", 20" and 22" depths
- Easy 4-screw installation
- Door mount brackets available (sold separately)

5WB2

- Designed for 12", 15", 18", 21", 24" and 27" base cabinets
- Chrome-plated round wire
- Full-extension, 100 lb. rated ball-bearing slides
- 7-screw installation
- (3) adjustable heights
- Mounts to cabinet floor, side and rear wall
- Telescoping rear mounting bracket
- U-shaped support bracket
- Door mount brackets available (sold separately)



SCAN FOR PRICING!



Door mount kit, sold separately



Adjustable rear mounting bracket



Top-down view of U-shaped support brackets

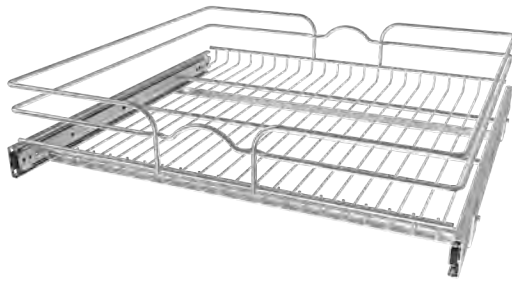

5WB1-2422CR-1
Single Chrome Wire Pullout
(Shelf for base 24" shown)

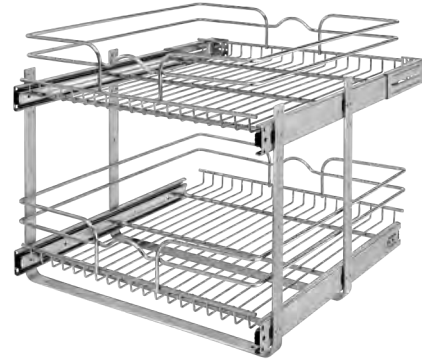

5WB2-2122CR-1
Two-Tier Chrome Wire Pullout
(Shelves for base 21" shown)

Chrome Wire Pullout Shelf

PRODUCT	DESCRIPTION	DIMS	MCOFF	CAB	FINISH	SLP
5WB1-0918CR-1	Pullout Shelf	8-1/2" (216 mm) W x 18" (457 mm) D x 5-17/32" (141 mm) H	8-1/2" (216 mm)	B12	Chrome	\$86.55
5WB1-1218CR-1	Pullout Shelf	11-1/2" (292 mm) W x 18" (457 mm) D x 5-17/32" (141 mm) H	11-1/2" (292 mm)	B15	Chrome	\$98.60
5WB1-1220CR-1	Pullout Shelf	11-1/2" (292 mm) W x 19-3/4" (502 mm) D x 5-17/32" (141 mm) H	11-1/2" (292 mm)	B15	Chrome	\$106.70
5WB1-1520CR-1	Pullout Shelf	14-1/2" (368 mm) W x 19-3/4" (502 mm) D x 5-17/32" (141 mm) H	14-1/2" (368 mm)	B18	Chrome	\$116.70
5WB1-1820CR-1	Pullout Shelf	17-1/2" (444 mm) W x 19-3/4" (502 mm) D x 5-17/32" (141 mm) H	17-1/2" (445 mm)	B21	Chrome	\$130.05
5WB1-2120CR-1	Pullout Shelf	20-1/2" (521 mm) W x 19-3/4" (502 mm) D x 5-17/32" (141 mm) H	20-1/2" (521 mm)	B24	Chrome	\$141.10
5WB1-1222CR-1	Pullout Shelf	11-1/2" (292 mm) W x 22" (559 mm) D x 5-17/32" (141 mm) H	11-1/2" (292 mm)	B15	Chrome	\$113.70
5WB1-1522CR-1	Pullout Shelf	14-1/2" (368 mm) W x 22" (559 mm) D x 5-17/32" (141 mm) H	14-1/2" (368 mm)	B18	Chrome	\$125.00
5WB1-1822CR-1	Pullout Shelf	17-1/2" (444 mm) W x 22" (559 mm) D x 5-17/32" (141 mm) H	17-1/2" (445 mm)	B21	Chrome	\$137.05
5WB1-2122CR-1	Pullout Shelf	20-1/2" (521 mm) W x 22" (559 mm) D x 5-17/32" (141 mm) H	20-1/2" (521 mm)	B24	Chrome	\$147.15
5WB1-2422CR-1	Pullout Shelf	23-1/2" (597 mm) W x 22" (559 mm) D x 5-17/32" (141 mm) H	23-1/2" (597 mm)	B27	Chrome	\$160.10

Two-Tier Chrome Wire Pullout Shelves

5WB2-0918CR-1	Pullout Shelves	8-3/4" (222 mm) W x 18-1/2" (470 mm) D x 16-1/4 - 19" (413 - 483 mm) H	8-1/2" (216 mm)	B12	Chrome	\$177.50
5WB2-1218CR-1	Pullout Shelves	11-3/4" (298 mm) W x 18-1/2" (470 mm) D x 16-1/4 - 19" (413 - 483 mm) H	11-1/2" (292 mm)	B15	Chrome	\$197.80
5WB2-0922CR-1	Pullout Shelves	8-3/4" (222 mm) W x 22-1/4" (565 mm) D x 16-1/4 - 19" (413 - 483 mm) H	8-1/2" (216 mm)	B12	Chrome	\$204.75
5WB2-1222CR-1	Pullout Shelves	11-3/4" (298 mm) W x 22-1/4" (565 mm) D x 16-1/4 - 19" (413 - 483 mm) H	11-1/2" (292 mm)	B15	Chrome	\$224.90
5WB2-1522CR-1	Pullout Shelves	14-3/4" (375 mm) W x 22-1/4" (565 mm) D x 16-1/4 - 19" (413 - 483 mm) H	14-1/2" (368 mm)	B18	Chrome	\$238.25
5WB2-1822CR-1	Pullout Shelves	17-3/4" (451 mm) W x 22-1/4" (565 mm) D x 16-1/4 - 19" (413 - 483 mm) H	17-1/2" (445 mm)	B21	Chrome	\$261.45
5WB2-2122CR-1	Pullout Shelves	20-3/4" (527 mm) W x 22-1/4" (565 mm) D x 16-1/4 - 19" (413 - 483 mm) H	20-1/2" (521 mm)	B24	Chrome	\$279.55
5WB2-2422CR-1	Pullout Shelves	23-3/4" (603 mm) W x 22-1/4" (565 mm) D x 16-1/4 - 19" (413 - 483 mm) H	23-1/2" (597 mm)	B27	Chrome	\$306.70

Accessories

5WB-DMKIT	Door Mount Kit for Wire Pullout				Chrome	\$42.35
-----------	---------------------------------	--	--	--	--------	---------



SCAN FOR PRICING!



- Designed for 15" and 24" base cabinets
- Chrome-plated wire frame
- (2) slide configurations:
 - Full-extension, ball-bearing slides, 100 lb. rated
 - Full-extension, ball-bearing slides, 100 lb. rated with soft-close
- Independently operating shelves that accommodate a variety of cookware sizes and brands
- Top tier organizes lids
- Bottom tier with adjustable dividers stores a variety of larger pots and pans
- Mounts to cabinet floor, side and rear wall
- US Patent No. D588,415
- U-shaped bracket for added support
- Door mount brackets available (sold separately)



5CW2-2122-CR



For video visit:
rev-a-shelf.com/videos

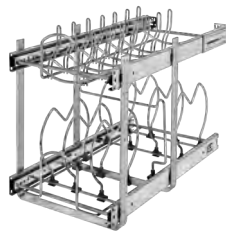

5CW2-1222-CR
 Cookware Organizer
 Holds (7) Lids

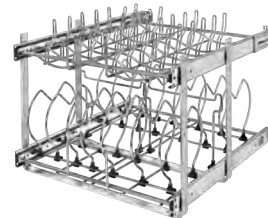

5CW2-2122-CR
 Cookware Organizer
 Holds (14) Lids



Door mount kit, sold separately

Two-Tier Cookware Organizer Pullout

PRODUCT	DESCRIPTION	DIMS	MCO	CAB	FINISH	SLP
5CW2-1222-CR	Cookware Organizer	11-3/4" (298 mm) W x 22" (559 mm) D x 18" (457 mm) H	12" (305 mm)	B15	Chrome	\$223.75
5CW2-2122-CR	Cookware Organizer	20-3/4" (527 mm) W x 22" (559 mm) D x 18-1/8" (460 mm) H	21" (533 mm)	B24	Chrome	\$382.05

Two-Tier Cookware Organizer w/ Ball-Bearing Soft-Close

5CW2-1222SC-CR	Cookware Organizer	11-3/4" (299 mm) W x 22" (559 mm) D x 18" (457 mm) H	12" (305 mm)	B15	Chrome	\$273.75
5CW2-2122SC-CR	Cookware Organizer	20-3/4" (527 mm) W x 22" (559 mm) D x 18-1/8" (460 mm) H	21" (533 mm)	B24	Chrome	\$438.75

Accessories

5WB-DMKIT	Door Mount Kit				Chrome	\$42.35
-----------	----------------	--	--	--	--------	---------



SCAN FOR PRICING!

Base Door Storage

4SBSU Series



4SBSU-15

- Designed for 15", 18" and 21" base cabinet doors
- Natural maple construction with semi-gloss finish
- Patented adjustable door mount brackets that provide up to 5" adjustability (US Patent No. 7,204,569)
- Easy 4-screw installation
- TSCA Title VI compliant



Includes removable top tray

Door Mount Base Door Storage

PRODUCT	DESCRIPTION	DIMS	MCO	CAB	FINISH	SLP
4SBSU-15	Door Storage	10-1/2" (267 mm) W x 5" (127 mm) D x 18-1/2" (470 mm) H	12" (305 mm)	B15	Maple	\$108.60
4SBSU-18	Door Storage	13-1/2" (343 mm) W x 5" (127 mm) D x 18-1/2" (470 mm) H	15" (381 mm)	B18	Maple	\$129.35
4SBSU-21	Door Storage	16-1/2" (419 mm) W x 5" (127 mm) D x 18-1/2" (470 mm) H	18" (457 mm)	B21	Maple	\$146.45

Grocery Bag Holder

4SPBD Series



4SPBD-15

- Designed for 15" and 18" base cabinet doors
- Natural maple construction with semi-gloss finish
- Patented adjustable door mount brackets that provide up to 5" adjustability (US Patent No. 7,204,569)
- TSCA Title VI Compliant



Includes removable top tray

Door Mount Grocery Bag Holder

PRODUCT	DESCRIPTION	DIMS	MCO	CAB	FINISH	SLP
4SPBD-15	Door Storage	10-1/2" (267 mm) W x 5" (127 mm) D x 18-5/8" (473 mm) H	12" (305 mm)	B15	Maple	\$128.45
4SPBD-18	Door Storage	13-1/2" (343 mm) W x 5" (127 mm) D x 18-5/8" (473 mm) H	15" (381 mm)	B18	Maple	\$141.10

Waste
Blind Corner
Sink
Base
Tall
Drawer
Wall
Vanity
Closet
Lazy Susan
LED Lighting



SCAN FOR PRICING!

Waste
Blind Corner
Sink
Base
Tall
Drawer
Wall
Vanity
Closet
Lazy Susan
LED Lighting

- Designed for 15" and 18" base cabinets
- Natural maple support rack with chrome-plated round wire
- Available with a mineral oil treated, maple hardwood cutting board or a Polyethylene cutting board
- Patented adjustable door mount brackets that provide up to 5" adjustability (US Patent No. 7,204,569)
- TSCA Title VI compliant



4DMCB-18



4DMCB-15
Wood Cutting Board
(15" Version shown)



4DMCB-18P
Polyethylene Cutting Board
(18" Version shown)

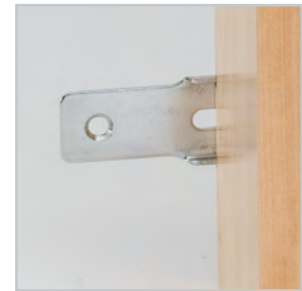

Adjustable Mounting Brackets
(US Patent No. 7,204,569)

Natural Maple Door Mount Cutting Board

PRODUCT	DESCRIPTION	DIMS	MCO	CAB	FINISH	SLP
4DMCB-15	Cutting Board	10-1/2" (267 mm) W x 2-7/8" (73 mm) D x 16-7/8" (429 mm) H	10-7/8" (305 mm) - FF 10-7/8" (305 mm) - FL	B15	Maple	\$126.60
4DMCB-18	Cutting Board	13-1/2" (343 mm) W x 2-7/8" (73 mm) D x 16-7/8" (429 mm) H	13-7/8" (352 mm) - FF 13-7/8" (352 mm) - FL	B18	Maple	\$142.95

Polyethylene Door Mount Cutting Board

4DMCB-15P	Cutting Board	11-5/16" (287 mm) W x 2" (51 mm) D x 16-7/16" (418 mm) H	12" (305 mm) - FF 12" (305 mm) - FL	B15	Polyethylene/Maple	\$111.35
4DMCB-18P	Cutting Board	14-3/4" (375 mm) W x 2" (51 mm) D x 16-7/16" (418 mm) H	15-1/4" (387 mm) - FF 15-1/4" (387 mm) - FL	B18	Polyethylene/Maple	\$133.55



SCAN FOR PRICING!

Door Storage Tray

4200 Series



- 8", 11", 14" and 20" width trays
- Natural maple construction with chrome-plated round wire
- (1) or (5) tray sets
- Easy-to-install screw-in clips
- Trays can also be mounted to 26" or 58" aluminum standards (sold separately)
- TSCA Title VI compliant

4231-11-52



14" Trays can be used with aluminum standards (Sold separately)



Bracket Extension Kit (Sold separately)



4231-08-52 Door Storage Tray (8" Version shown)

NOTE: Additional tray clips may be ordered - Part No: 6231-41-4101-10

Wood Door Mount Storage Tray w/ Screw-In Clips

PRODUCT	DESCRIPTION	DIMS	MCO	CAB	FINISH	SLP
4231-08-52	8" Storage Tray	7-3/4" (197 mm) W x 4-1/4" (108 mm) D x 3-5/8" (92 mm) H	9" (229 mm)	B12	Maple	\$52.65
4231-11-52	11" Storage Tray	10-3/4" (273 mm) W x 4-1/4" (108 mm) D x 3-5/8" (92 mm) H	12" (305 mm)	B15	Maple	\$63.05
4231-14-52	14" Storage Tray	13-3/4" (349 mm) W x 4-1/4" (108 mm) D x 3-5/8" (92 mm) H	15" (381 mm)	B18	Maple	\$65.25
4231-20-52	20" Storage Tray	19-3/4" (502 mm) W x 4-1/4" (108 mm) D x 3-5/8" (92 mm) H	21" (533 mm)	B24	Maple	\$68.00

(5) Wood Door Mount Storage Trays w/ Screw-In Clips

4235-11-5	11" Storage Trays	10-3/4" (273 mm) W x 4-1/4" (108 mm) D x 3-5/8" (92 mm) H	12" (305 mm)	B15	Maple	\$57.15 ea.
4235-14-5	14" Storage Trays	13-3/4" (349 mm) W x 4-1/4" (108 mm) D x 3-5/8" (92 mm) H	15" (381 mm)	B18	Maple	\$59.45 ea.
4235-20-5	20" Storage Trays	19-3/4" (502 mm) W x 4-1/4" (108 mm) D x 3-5/8" (92 mm) H	21" (533 mm)	B24	Maple	\$62.35 ea.

Accessories

6230-MB-11-1	Mounting Bracket Extension Kit				White	\$15.95
6232-26-4528-52	Pair Aluminum Standards w/ (4) Clips	1/2" (13 mm) W x 1/8 - 1-1/4" (3 - 32 mm) D x 26" (660 mm) H			Alum	\$64.10
6232-58-4528-52	Pair Aluminum Standards w/ (10) Clips	1/2" (13 mm) W x 1/8 - 1-1/4" (3 - 32 mm) D x 58" (1473 mm) H			Alum	\$98.15



SCAN FOR PRICING!

- Designed for 36" full height base cabinets
- Kit includes (2) swing out units and (2) door storage units
- Natural maple construction with semi-gloss finish
- Adjustable interior door and pantry shelves
- Chrome-plated accents
- Industrial piano hinge
- Patented adjustable door mount brackets that provide up to 5" of adjustability (US Patent No. 7,204,569)
- TSCA Title VI compliant



4WBP18-25-KIT
Swing Out Pantry Kit
(2) 4WBSP18-25 and (2) 4WBDP18-25

Chrome top rails can be installed to store items

NOTE: Minimum CABINET Height: 4WBP18-25-KIT = 25-3/4" (654 mm) without top rails or 28-3/4" (730 mm) with top rails

Swing Out Pantry						
PRODUCT	DESCRIPTION	DIMS	MCO	CAB	FINISH	SLP
4WBP18-25-KIT	25" Swing Out Pantry Kit - Includes (2) 4WBSP18-25 and (2) 4WBDP18-25		33" (838 mm)	FHB36	Maple	\$665.55
4WBSP18-25	(1) 25" Swing Out Pantry Unit w/ Hardware	12" (305 mm) W x 7-1/2" (190 mm) D x 25" (635 mm) H	33" (838 mm)	FHB36	Maple	\$174.70
4WBDP18-25	(1) 25" Pantry Door Unit w/ Hardware	12" (305 mm) W x 4" (102 mm) D x 25" (635 mm) H	15-1/4" (387 mm)	FHB36	Maple	\$148.90



SCAN FOR PRICING!

Vanity Storage Rack

4VR Series

Waste

Blind Corner

Sink

Base

Tall

Drawer

Wall

Vanity

Closet

Lazy Susan

LED Lighting



- Designed for 12", 15", 18", 21" and 24" vanity base cabinets
- Natural maple frame with semi-gloss finish
- Mounts to cabinet door
- Patented adjustable door mount brackets that provide up to 5" adjustability (US Patent No. 7,204,569)
- (2) non-skid vinyl shelves with acrylic accents
- TSCA Title VI compliant

4VR-15-1



Adjustable Mounting Brackets
(US Patent No. 7,204,569)



4VR-12-1
Storage Rack
(12" version shown)



4VR-21-1
Storage Rack
(21" version shown)

Door Mount Vanity Storage Rack

PRODUCT	DESCRIPTION	DIMS	MCO	CAB	FINISH	SLP
4VR-12-1	Storage Rack for 12"	8-1/4" (210 mm) W x 3-1/8" (79 mm) D x 15-1/2" (394 mm) H	9" (229 mm)	VB12	Maple	\$108.75
4VR-15-1	Storage Rack for 15"	11-1/4" (286 mm) W x 3-1/8" (79 mm) D x 15-1/2" (394 mm) H	12" (305 mm)	VB15	Maple	\$119.20
4VR-18-1	Storage Rack for 18"	14-1/4" (362 mm) W x 3-1/8" (79 mm) D x 15-1/2" (394 mm) H	15" (381 mm)	VB18	Maple	\$137.30
4VR-21-1	Storage Rack for 21"	17-1/4" (438 mm) W x 3-1/8" (79 mm) D x 15-1/2" (394 mm) H	18" (457 mm)	VB21	Maple	\$120.80
4VR-24-1	Storage Rack for 24"	20-1/4" (514 mm) W x 3-1/8" (79 mm) D x 15-1/2" (394 mm) H	21" (533 mm)	VB24	Maple	\$125.70



SCAN FOR PRICING!

Waste
Blind Corner
Sink
Base
Tall
Drawer
Wall
Vanity
Closet
Lazy Susan
LED Lighting

- Designed for 15" and 18" base cabinets
- (1) woven nylon basket:
 - Espresso with natural maple rails and semi-gloss finish
 - Espresso with walnut rails and satin finish
- 6-screw installation
- Trim-to-fit rails
- Rails are natural maple with semi-gloss finish or walnut with satin finish
- Mounts to cabinet side walls
- (1) machine washable canvas liner
- TSCA Title VI compliant



4WV-15MP
Woven Basket with Rails
(15" Maple Version shown)



4WV-18WN
Woven nylon construction

PART	Inside Cabinet Width (Min.)	Inside Cabinet Width (Max.)	Basket Frame Width
4WV-15MP	12-3/8" (314 mm)	14-11/16" (373 mm)	11-5/16" (287 mm)
4WV-15WN	12-3/8" (314 mm)	14-11/16" (373 mm)	11-5/16" (287 mm)
4WV-18MP	15-3/8" (391 mm)	17-11/16" (449 mm)	14-5/16" (379 mm)
4WV-18WN	15-3/8" (391 mm)	17-11/16" (449 mm)	14-5/16" (379 mm)

Woven Basket w/ Rails

PRODUCT	DESCRIPTION	DIMS	MCO	CAB	FINISH	SLP
4WV-15MP	Woven Basket with Maple Rails	14-11/16" (373 mm) W x 21-1/4" (540 mm) D x 7-3/8" (188 mm) H	12" (305 mm) - FF 12-3/8" (315 mm) - FL	B15	Maple	\$180.25
4WV-15WN	Woven Basket with Walnut Rails	14-11/16" (373 mm) W x 21-1/4" (540 mm) D x 7-3/8" (188 mm) H	12" (305 mm) - FF 12-3/8" (315 mm) - FL	B15	Walnut	\$285.65
4WV-18MP	Woven Basket with Maple Rails	17-11/16" (449 mm) W x 21-1/4" (540 mm) D x 7-3/8" (188 mm) H	15" (381 mm) - FF 15-3/8" (391 mm) - FL	B18	Maple	\$189.80
4WV-18WN	Woven Basket with Walnut Rails	17-11/16" (449 mm) W x 21-1/4" (540 mm) D x 7-3/8" (188 mm) H	15" (381 mm) - FF 15-3/8" (391 mm) - FL	B18	Walnut	\$304.05



SCAN FOR PRICING!

Towel Bar Base Filler Pullout

432TB Series



- Designed for 3" and 6" base cabinet applications
- Natural maple construction with semi-gloss finish
- (2) towel bars
- Single static shelf with chrome wire accents
- Full-extension, ball-bearing slides with soft-close
- Mounts between cabinets
- TSCA Title VI compliant

432TB-BFBBSC-3C

Natural Maple Towel Bar Base Cabinet Filler w/ Ball-Bearing Soft-Close

PRODUCT	DESCRIPTION	DIMS	FINISH	SLP
432TB-BFBBSC-3C	3" Filler	3" (76 mm) W x 23" (584 mm) D x 30" (762 mm) H	Maple	\$329.15
432TB-BFBBSC-6C	6" Filler	6" (152 mm) W x 23" (584 mm) D x 30" (762 mm) H	Maple	\$449.20



SCAN FOR PRICING!



- Designed for 12", 15", 18" and 21" base cabinets
- 12" available in two depths, 18" and 22"
- Natural maple dovetail construction with semi-gloss finish
- 3/4 extension, 33 lb. rated slides with soft-close
- Mounts to cabinet floor
- TSCA Title VI compliant



4WDB-1522SC-1



4WDB-1218SC-1
Drawer Pullout
(12" Version shown)



3/4 extension soft-close slide

Drawer Pullout w/ 3/4 Extension Soft-Close

PRODUCT	DESCRIPTION	DIMS	MCO	CAB	FINISH	SLP
4WDB-1218SC-1	Pullout Drawer	11" (279 mm) W x 18-3/8" (467 mm) D x 5-21/32" (144 mm) H	12" (305 mm)	B15	Maple	\$105.85
4WDB-1222SC-1	Pullout Drawer	11" (279 mm) W x 22-3/8" (568 mm) D x 5-21/32" (144 mm) H	12" (305 mm)	B15	Maple	\$110.65
4WDB-1522SC-1	Pullout Drawer	14" (356 mm) W x 22-3/8" (568 mm) D x 5-21/32" (144 mm) H	15" (381 mm)	B18	Maple	\$122.50
4WDB-1822SC-1	Pullout Drawer	17" (432 mm) W x 22-3/8" (568 mm) D x 5-21/32" (144 mm) H	18" (457 mm)	B21	Maple	\$144.85
4WDB-2122SC-1	Pullout Drawer	20" (508 mm) W x 22-3/8" (568 mm) D x 5-21/32" (144 mm) H	21" (533 mm)	B24	Maple	\$170.40

Waste

Blind Corner

Sink

Base

Tall

Drawer

Wall

Vanity

Closet

Lazy Susan

LED Lighting



SCAN FOR PRICING!

Drawer Pullout

4WDB* Series



- Designed for 15" and 18" base cabinets
- Veneer plywood dovetail construction
- 3/4 extension or full-extension BLUM soft-close undermount slides
- Tall drawers feature peg board bottoms with (3, 4) maple pegs and (6, 8) metal dividers
- TSCA Title VI compliant

4WDB7-24SC-1/4WDB4-18SC-1

Pictured with our K-Cup Insert, sold separately (three units shown)



4WDB7-24SC-1

Drawer Pullout

(24" with dividers version shown)

Drawer Pullout w/ BLUMOTION Soft-Close

PRODUCT	DESCRIPTION	DIMS	MCO	CAB	FINISH	SLP
4WDB4-18SC-1	Standard Drawer	14-1/16" (357 mm) W x 21-5/8" (550 mm) D x 4-27/32" (123 mm) H	15" (381 mm)	B18	Maple	\$372.35
4WDB7-18SC-1	Tall Drawer with dividers	14-1/16" (357 mm) W x 21-5/8" (550 mm) D x 8" (203 mm) H	15" (381 mm)	B18	Maple	\$472.25
4WDB4-24SC-1	Standard Drawer	20-1/16" (510 mm) W x 21-5/8" (550 mm) D x 4-27/32" (123 mm) H	21" (533 mm)	B24	Maple	\$423.10
4WDB7-24SC-1	Tall Drawer with dividers	20-1/16" (510 mm) W x 21-5/8" (550 mm) D x 8" (203 mm) H	21" (533 mm)	B24	Maple	\$544.60



SCAN FOR PRICING!



4PIL-18SC-2



For video visit:
rev-a-shelf.com/videos



- Designed for 18" (14-1/4" minimum cabinet opening) and 24" (20-1/4" minimum cabinet opening) base cabinets
- Double and triple drawer options available
- Tall drawers feature peg board bottoms with (3,4) maple pegs and (6,8) metal dividers
- 3/4 extension, soft-close slides or full-extension, BLUM soft-close undermount slides
- Stackable for use in pantry applications
- Easily adjustable drawer height locations for storing tall and short items
- TSCA Title VI compliant

Minimum Cabinet Opening

PRODUCT #	MCO FF	MCO FL
4PIL-18SC-SV-2	14-1/4" (362 mm)	16-1/2" (419 mm)
4PIL-18SC-SV-3	14-1/4" (362 mm)	16-1/2" (419 mm)
4PIL-24SC-SV-2	20-1/4" (514 mm)	22-1/2" (572 mm)
4PIL-24SC-SV-3	20-1/4" (514 mm)	22-1/2" (572 mm)
4PIL-18SC-2	14-1/4" (362 mm)	16-1/2" (419 mm)
4PIL-18SC-3	14-1/4" (362 mm)	16-1/2" (419 mm)
4PIL-24SC-2	20-1/4" (514 mm)	22-1/2" (572 mm)
4PIL-24SC-3	20-1/4" (514 mm)	22-1/2" (572 mm)
4WDB4-PIL-18SC-1	14-1/4" (362 mm)	16-1/2" (419 mm)
4WDB7-PIL-18SC-1	14-1/4" (362 mm)	16-1/2" (419 mm)
4WDB4-PIL-24SC-1	20-1/4" (514 mm)	22-1/2" (572 mm)
4WDB7-PIL-24SC-1	20-1/4" (514 mm)	22-1/2" (572 mm)

NOTE: See page 176 to see the Pilaster System in a pantry application



SCAN FOR PRICING!



4PIL-18SC-3
Pilaster System Kit
(2 Standard, (1) tall and brown finish shown)



4PIL-24SC-SV-2
Pilaster System Kit
(1 Standard, (1) tall and silver finish shown)



4WDB7-PIL-24SC-1
Tall Drawer w/ Dividers
(24" version shown)



4WDB4-PIL-18SC-1
Standard Drawer
(18" version shown)

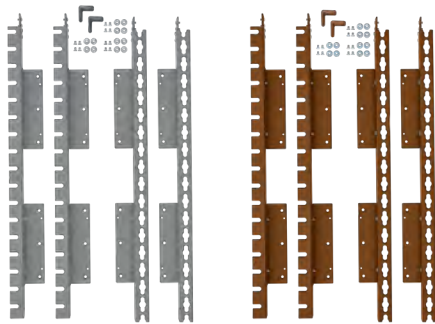

4PIL-21SV-1 & 4PIL-21-1
Pilaster Uprights
(Silver and brown finish shown)

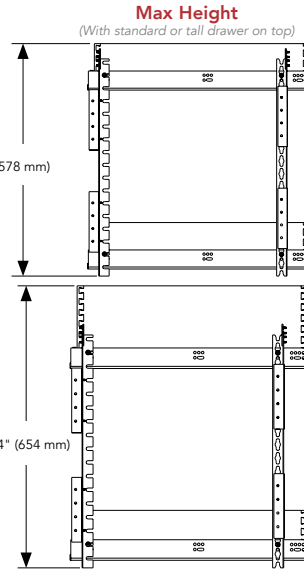

4PIL-BUTTON-1
Pilaster slide attachment buttons



*Adjustable +/- 3/8". †Adjustable to 2".

Pilaster System Kits w/ BLUMOTION Soft-Close - Slides and Uprights - Silver

PRODUCT	DESCRIPTION	DIMS	CAB	FINISH	SLP
4PIL-18SC-SV-2	(1) Standard, (1) Tall w/ Dividers	16-1/2" (419 mm) W* x 22-1/16" (560 mm) D x 21-1/4" - 25-3/4" (540 - 654 mm) H	B18	Maple	\$733.70
4PIL-18SC-SV-3	(2) Standard, (1) Tall w/ Dividers	16-1/2" (419 mm) W* x 22-1/16" (560 mm) D x 23-3/4" - 25-3/4" (603 - 654 mm) H	B18	Maple	\$992.40
4PIL-24SC-SV-2	(1) Standard, (1) Tall w/ Dividers	22-1/2" (572 mm) W* x 22-1/16" (560 mm) D x 21-1/4" - 25-3/4" (540 - 654 mm) H	B24	Maple	\$818.95
4PIL-24SC-SV-3	(2) Standard, (1) Tall w/ Dividers	22-1/2" (572 mm) W* x 22-1/16" (560 mm) D x 23-3/4" - 25-3/4" (603 - 654 mm) H	B24	Maple	\$1106.95

Pilaster System Kits - w/ BLUMOTION Soft-Close - Slides and Uprights - Brown

4PIL-18SC-2	(1) Standard, (1) Tall w/ Dividers	16-1/2" (419 mm) W* x 22-1/16" (560 mm) D x 21-1/4" - 25-3/4" (540 - 654 mm) H	B18	Maple	\$737.05
4PIL-18SC-3	(2) Standard, (1) Tall w/ Dividers	16-1/2" (419 mm) W* x 22-1/16" (560 mm) D x 23-3/4" - 25-3/4" (603 - 654 mm) H	B18	Maple	\$996.75
4PIL-24SC-2	(1) Standard, (1) Tall w/ Dividers	22-1/2" (572 mm) W* x 22-1/16" (560 mm) D x 21-1/4" - 25-3/4" (540 - 654 mm) H	B24	Maple	\$818.80
4PIL-24SC-3	(2) Standard, (1) Tall w/ Dividers	22-1/2" (572 mm) W* x 22-1/16" (560 mm) D x 23-3/4" - 25-3/4" (603 - 654 mm) H	B24	Maple	\$1112.15

Pilaster Kits - Uprights Only

4PIL-21-SV-1	Pilaster Upright Kit	1" (25 mm) W† x 1" (25 mm) D x 21-1/4" (540 mm) H	Silver	\$110.35
4PIL-21-SV-10	(10) Pilaster Upright Kits		Silver	\$94.10 ea.
4PIL-21-1	Pilaster Upright Kit	1" (25 mm) W† x 1" (25 mm) D x 21-1/4" (540 mm) H	Brown	\$102.10
4PIL-21-10	(10) Pilaster Upright Kits		Brown	\$94.25ea.

Pilaster Buttons

4PIL-BUTTON-1	Pilaster upright button kit for slide attach (1 set of 4 buttons)		Silver	\$7.40
4PIL-BUTTON-12	Pilaster upright buttons for slide attach (12 sets of 4 buttons)		Silver	\$3.05 ea.

Drawer Box w/ BLUMOTION Soft-Close

PRODUCT	DESCRIPTION	DIMS	CAB	FINISH	SLP
4WDB4-PIL-18SC-1	(1) Standard drawer	13-5/16" (339 mm) W x 21" (533 mm) D x 4" (102 mm) H (drawers only)	B18	Maple	\$315.95
4WDB7-PIL-18SC-1	(1) Tall drawer w/ dividers	13-5/16" (339 mm) W x 21" (533 mm) D x 7" (178 mm) H (drawers only)	B18	Maple	\$415.70
4WDB4-PIL-24SC-1	(1) Standard drawer for 24"	19-5/16" (491 mm) W x 21" (533 mm) D x 4" (102 mm) H (drawers only)	B24	Maple	\$349.45
4WDB7-PIL-24SC-1	(1) Tall drawer w/ dividers	19-5/16" (491 mm) W x 21" (533 mm) D x 7" (178 mm) H (drawers only)	B24	Maple	\$470.25

Waste
Blind Corner
Sink
Base
Tall
Drawer
Wall
Vanity
Closet
Susan
Lazy
LED
Lighting



SCAN FOR PRICING!



- Designed for 18" and 24" base cabinets
- Natural maple dovetail construction with semi-gloss finish
- Adjustable clip-on lid dividers (5 w/ 18") (8 w/ 24")
- (7) customizable metal dividers
- Full-extension with 3/4" over-travel BLUM MOVENTO soft-close undermount slides
- Mounts to cabinet floor
- US Patent No. D758,112
- TSCA Title VI compliant



4FSCO-24SC-1



4FSCO-18SC-1
Food Storage Container Organizer
(18" Version shown)



Clip-on lid dividers

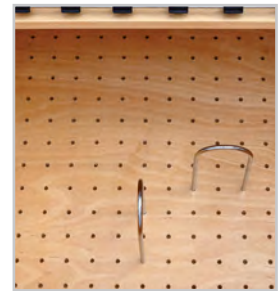

Versatile peg board with (7) metal dividers



For video visit:
rev-a-shelf.com/videos

Food Storage Container Organizer w/ MOVENTO Soft-Close

PRODUCT	DESCRIPTION	DIMS	MCO	CAB	FINISH	SLP
4FSCO-18SC-1	Food Storage Container Organizer	14-1/2" (368 mm) W x 22-3/8" (568 mm) D x 18-7/8" (479 mm) H	14-1/2" (368 mm)	B18	Maple	\$564.50
4FSCO-24SC-1	Food Storage Container Organizer	20-1/2" (521 mm) W x 21-1/4" (540 mm) D x 18-7/8" (479 mm) H	20-1/2" (521 mm)	B24	Maple	\$619.60



SCAN FOR PRICING!

Base Cabinet Filler

432 Series

Waste

Blind Corner

Sink

Base

Tall

Drawer

Wall

Vanity

Closet

Lazy Susan

LED Lighting



- Designed for 3", 6" and 9" base filler applications
- Natural maple construction with semi-gloss finish
- (2) slide configurations:
 - Full-extension, ball-bearing slides
 - Full-extension slides with ball-bearing soft-close
- Adjustable shelves with chrome rails
- 3-slide design for 6" and 9" base cabinet fillers
- Create a functional storage space behind decorative panels
- TSCA Title VI compliant

432-BFBBSC-3C



432-BF-3C
Base Cabinet Filler
(3" Version shown)



432-BFBBSC-6C
Base Cabinet Filler
w/ Ball-Bearing Soft-Close
(6" Version shown)

NOTE: See page 238 for wall cabinet version

Base Cabinet Filler w/ Ball-Bearing Soft-Close

PRODUCT	DESCRIPTION	DIMS	FINISH	SLP
432-BFBBSC-3C	3" Base Filler Organizer	3" (76 mm) W x 23" (584 mm) D x 30" (762 mm) H	Maple	\$306.40
432-BFBBSC-6C	6" Base Filler Organizer	6" (152 mm) W x 23" (584 mm) D x 30" (762 mm) H	Maple	\$426.30

Base Cabinet Filler

432-BF-3C	3" Base Filler Organizer	3" (76 mm) W x 23" (584 mm) D x 30" (762 mm) H	Maple	\$264.50
432-BF-6C	6" Base Filler Organizer	6" (152 mm) W x 23" (584 mm) D x 30" (762 mm) H	Maple	\$368.00
432-BF-9C	9" Base Filler Organizer	9" (229 mm) W x 23" (584 mm) D x 30" (762 mm) H	Maple	\$536.80



SCAN FOR PRICING!



- Designed for 3", 6" and 9" base filler applications
- Natural maple construction with semi-gloss finish
- Full-extension, BLUM soft-close undermount slides
- Patented undermount soft-close slide system (US Patent No. 8,733,865)
- (2) Adjustable shelves with chrome rails
- Fixed middle shelf for added support
- Create a functional storage space behind those decorative panels
- TSCA Title VI compliant



432-BFSC-3C



432-BFSC-6C
Base Cabinet Filler
(6" version shown)



432-BFSC-9C
Base Cabinet Filler
(9" version shown)

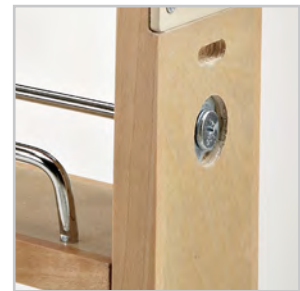

Jack screw for door micro-adjustments

Base Cabinet Filler w/ BLUMOTION Soft-Close

PRODUCT	DESCRIPTION	DIMS	FINISH	SLP
432-BFSC-3C	3" Base Filler Organizer	3" (76 mm) W x 23" (584 mm) D x 30" (762 mm) H	Maple	\$414.70
432-BFSC-6C	6" Base Filler Organizer	6" (152 mm) W x 23" (584 mm) D x 30" (762 mm) H	Maple	\$497.50
432-BFSC-9C	9" Base Filler Organizer	9" (229 mm) W x 23" (584 mm) D x 30" (762 mm) H	Maple	\$588.25



SCAN FOR PRICING!

Hybrid Base Cabinet Filler

433 Series



- Designed for 9" base filler applications
- One side features adjustable 2-3/4" wide shelves
- Opposite side features magnetic grade stainless steel panel
- (2) slide configurations:
 - Full-extension, ball-bearing slides
 - Full-extension, ball-bearing slides with soft-close
- Adjustable accessory hooks included
- Additional accessory hooks can be purchased separately (pg. 145)
- TSCA Title VI compliant

433-BF-9C



Magnetic grade stainless steel panel



433-BFBBSC-9C
Hybrid base cabinet filler w/ customizable accessory hooks

Hybrid Base Cabinet Filler

PRODUCT	DESCRIPTION	DIMS	FINISH	SLP
433-BF-9C	9" Base Filler Organizer	9" (229 mm) W x 23" (584 mm) D x 30" (762 mm) H	Maple	\$631.75
433-BFBBSC-9C	9" Base Filler Organizer w/ Soft-Close	9" (229 mm) W x 23" (584 mm) D x 30" (762 mm) H	Maple	\$698.15

Waste
Blind Corner
Sink
Base
Tall
Drawer
Wall
Vanity
Closet
Susan
Lazy
LED Lighting



SCAN FOR PRICING!



434-BFBBSC-3SS



- Designed for 3" and 6" base filler applications
- (2) slide configurations:
 - Full-extension, 100 lb. rated ball-bearing slides with soft-close
 - Full-extension ball-bearing slides
- Magnetic grade stainless steel panel
- Variety of accessory hooks and pegs included
- Additional accessory hooks can be purchased separately
- TSCA Title VI compliant

NOTE: See page for 248 for wall cabinet version



SCAN FOR PRICING!



Sewing application



Magnetic grade stainless steel panel



434-BF-3C
Base Cabinet Filler
(3" version shown)



434-BCSC-6C
Base Cabinet Filler w/ Soft-Close
(6" version shown)



434-S3-5
3" Single Hook



434-S6-5
6" Single Hook



434-D3-5
3" Double Hook



434-D6-5
6" Double Hook



434-PEG3-6
3" Peg



434-PEG6-6
6" Peg

Base Cabinet Filler w/ Stainless Steel Panel and Ball-Bearing Soft-Close

PRODUCT	DESCRIPTION	DIMS	FINISH	SLP
434-BFBBSC-3SS	3" Base Filler Organizer	3" (76 mm) W x 23" (584 mm) D x 30" (762 mm) H	Maple	\$410.65
434-BFBBSC-6SS	6" Base Filler Organizer	6" (152 mm) W x 23" (584 mm) D x 30" (762 mm) H	Maple	\$569.85

Base Cabinet Filler w/ Stainless Steel Panel

434-BF-3SS	3" Base Filler Organizer	3" (76 mm) W x 23" (584 mm) D x 30" (762 mm) H	Maple	\$427.60
434-BF-6SS	6" Base Filler Organizer	6" (152 mm) W x 23" (584 mm) D x 30" (762 mm) H	Maple	\$503.30

Bulk Accessories

434-S3-5	(5) 3" Single Hook			\$2.25 ea.
434-D3-5	(5) 3" Double Hook			\$2.25 ea.
434-PEG3-6	(6) 3" Peg			\$4.30 ea.
434-S6-5	(5) 6" Single Hook			\$4.20 ea.
434-D6-5	(5) 6" Double Hook			\$5.60 ea.
434-PEG6-6	(6) 6" Peg			\$6.20 ea.



SCAN FOR PRICING!



- Designed for full height 6" and 9" base cabinets
- Fully assembled natural maple construction with chrome accents
- (2) slide configurations:
 - Full-extension, ball-bearing, 100 lb. rated slides
 - Full-extension, BLUM soft-close undermount slides
- Patented undermount soft-close slide system (US Patent No. 8,733,865)
- Trimmable to 26-3/8" height for custom cabinets
- Adjustable shelves
- Designed with top slide for complete stability
- TSCA Title VI compliant



438-BC-3C



438-BCSC-6C
Base Organizer
(6" version shown)

NOTE: Our customers asked... so we delivered! We took the best features of our 448 Series Base Organizers and our 432 Series Filler Organizers and created this product specifically for use in full height B6 and B9 cabinets.

Base Organizer

PRODUCT	DESCRIPTION	DIMS	MCO	CAB	FINISH	SLP
438-BC-3C	Base Organizer for 6"	3" (76 mm) W x 23" (584 mm) D x 27-5/16" (694 mm) H	3" (76 mm)	FHB6	Maple	\$258.40
438-BC-6C	Base Organizer for 9"	6" (152 mm) W x 23" (584 mm) D x 27-5/16" (694 mm) H	6" (152 mm)	FHB9	Maple	\$369.60

Base Organizer w/ BLUMOTION Soft-Close

438-BCSC-3C	Base Organizer for 6"	3" (76 mm) W x 23" (584 mm) D x 27-5/16" (694 mm) H	3" (76 mm)	FHB6	Maple	\$458.05
438-BCSC-6C	Base Organizer for 9"	6" (152 mm) W x 23" (584 mm) D x 27-5/16" (694 mm) H	6" (152 mm)	FHB9	Maple	\$557.80



Base Cabinet Pullout w/ Stainless Steel Panel

444 Series

SCAN FOR PRICING!



- Designed for 12" full height base cabinets
- Natural maple construction with a semi-gloss finish
- (2) slide configurations:
 - Full-extension, ball-bearing, 100 lb. rated slides
 - Full-extension, BLUM soft-close undermount slides
- Patented mounting straps (US Patent No. 9,756,941)
- Features a magnetic grade stainless steel panel and an array of accessory hooks
- Patented door mount brackets provide 5" of adjustability (US Patent No: 8,388,076)
- Adjustable rub bushings
- Additional accessory hooks can be purchased separately, (pg. 145)
- TSCA Title VI compliant

444-BCSC-8SS



Magnetic grade stainless steel panel



444-BCSC-8SS
Base Organizer w/ BLUMOTION Soft-Close

NOTE: See page 249 for wall cabinet version



Adjustable threaded rub bushings included for custom applications



Plastic rub bushings included for 1-1/2" and 1-3/4" face frame applications

Base Cabinet Pullout Organizer w/ Stainless Steel Panel

PRODUCT	DESCRIPTION	DIMS	MCO	CAB	FINISH	SLP
444-BC-8SS	Base Organizer	8" (203 mm) W x 22-1/2" (572 mm) D x 25-1/2" (648 mm) H	8-1/2" (216 mm)	FHB12	Maple	\$490.95

Base Organizer w/ Stainless Steel Panel and BLUMOTION Soft-Close

444-BCSC-8SS	Base Organizer	8-3/4" (222 mm) W x 21-5/8" (550 mm) D x 25-1/2" (648 mm) H	9" (229 mm) - FF 8-3/4" (222 mm) - FL	FHB12	Maple	\$635.80
--------------	----------------	---	--	-------	-------	----------

Waste
Blind Corner
Sink
Base
Tall
Drawer
Wall
Vanity
Closet
Susan
Lazy
LED Lighting



SCAN FOR PRICING!



448-BCBBS-8C



All Units:

- Natural maple construction with a semi-gloss finish
- Adjustable shelves with chrome rails
- Patented door mount brackets provide 5" of adjustability and include micro-trim adjuster (US Patent No. 8,388,076)
- TSCA Title VI compliant

Soft-Close Units:

- Designed for 9" and 12" full height face frame base cabinets
- Full-extension, 150 lb. rated, ball-bearing slides with soft-close
- Adjustable rub bushings

Ball-Bearing Units:

- Designed for 9", 12", 15" and 18" full height face frame base cabinets, and 9" full height frameless cabinets
- Patented "tri-slides" which minimize any side-to-side motion (US Patent No. 7,306,301)
- Patented mounting straps (US Patent No. 9,756,941)

Minimum Cabinet Opening

PRODUCT #	MCO FF	MCO FL
448-BCBBS-5C	5-1/2" (140 mm)	5-1/2" (140 mm)
448-BCBBS-8C	8-1/2" (216 mm)	8-1/2" (216 mm)
448-BC-5C	5-1/2" (140 mm)	5-1/2" (140 mm)
448-BC-6C	7" (178 mm)	7" (178 mm)
448-BC-8C	8-1/2" (216 mm)	8-1/2" (216 mm)
448-BC-11C	11-1/2" (292 mm)	11-1/2" (292 mm)
448-BC-14C	14-1/2" (368 mm)	14-1/2" (368 mm)

NOTE: See page 230 for wall cabinet version

Waste
Blind Corner
Sink
Base
Tail
Drawer
Wall
Vanity
Closet
Lazy Susan
LED Lighting



SCAN FOR PRICING!
PRICING!

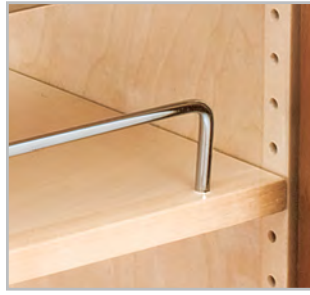

Adjustable shelves



Adjustable door mount brackets (US Patent No: 8,388,076) and jack screw for precise door alignment



Adjustable rear wall



448-BC-8C
Base Cabinet Pullout
(8" version shown)



448-BCBBS-5C
Base Cabinet Pullout w/ Soft-Close
(5" version shown)



Adjustable threaded rub bushings included for custom applications



Plastic rub bushings included for 1.5" and 1.75" face frame applications



IDRB-1
Adjustable Rub Bushing set for Inset Applications (1) for each side
(Sold separately)

(For inset applications we recommend our IDRBS bushing. The discreet design prevents side to side movement and fits behind the frame eliminating the need for surface drilling-giving you a seamless look and unparalleled stability.)



448-08SC-SRI-1
Spice Rack Insert
(448-BCBBS-8C version shown)
(Sold separately)

Base Cabinet Pullout w/ Ball-Bearing Soft-Close

PRODUCT	DESCRIPTION	DIMS	CAB	FINISH	SLP
448-BCBBS-5C	Base Organizer	5" (127 mm) W x 21-5/8" (550 mm) D x 25-1/2 - 29-1/2" (648 - 749 mm) H	FHB9	Maple	\$381.20
448-BCBBS-8C	Base Organizer	8" (203 mm) W x 21-5/8" (550 mm) D x 25-1/2 - 29-1/2" (648 - 749 mm) H	FHB12	Maple	\$416.15

Base Cabinet Pullout

448-BC-5C	Base Organizer	5" (127 mm) W x 22-1/2" (572 mm) D x 25-1/2" (648 mm) H	FHB9	Maple	\$297.40
448-BC-6C	Frameless Organizer	6-1/2" (165 mm) W x 22-1/2" (572 mm) D x 25-1/2" (648 mm) H	FHB9	Maple	\$328.15
448-BC-8C	Base Organizer	8" (203 mm) W x 22-1/2" (572 mm) D x 25-1/2" (648 mm) H	FHB12	Maple	\$374.70
448-BC-11C	Base Organizer	11" (279 mm) W x 22-1/2" (572 mm) D x 25-1/2" (648 mm) H	FHB15	Maple	\$488.35
448-BC-14C	Base Organizer	14" (356 mm) W x 22-1/2" (572 mm) D x 25-1/2" (648 mm) H	FHB18	Maple	\$587.55

Spice Rack Insert for Base Cabinet Pullout

448-08SC-SRI-1	For 448-BCBBS-8C	7" (178 mm) W x 19-7/16" (494 mm) D x 4-27/32" (124 mm) H		Maple	\$100.50
448-SR8-1	For 448-BC-8C	7" (178 mm) W x 21" (533 mm) D x 4-7/8" (124 mm) H		Maple	\$79.00
448-SR11-1	For 448-BC-11C	10" (254 mm) W x 21" (533 mm) D x 4-7/8" (124 mm) H		Maple	\$100.20

Accessories

IDRB-1	Adjustable Rub Bushing for Inset Applications			Metal	\$16.80
--------	---	--	--	-------	---------

Waste
Blind Corner
Sink
Base
Tall
Drawer
Wall
Vanity
Closet
Susan
Lazy
LED Lighting



SCAN FOR PRICING!



- Designed for full access 9" and 12", face frame 9", 12", 15" and 18" full height and 9", 12" and 15" drawer/door base cabinets
- Natural maple construction with semi-gloss finish
- Full-extension, BLUM soft-close undermount slides
- Patented mounting straps (US Patent No. 9,756,941)
- Adjustable shelves with chrome rails
- Adjustable rub bushings
- Patented door mount brackets provide 5" of adjustability and include micro-trim adjuster (US Patent No. 8,388,076)
- TSCA Title VI compliant

448-BCSC-8C & 448-08SC-SRI-1



For video visit:
rev-a-shelf.com/videos

448-BDDSC-11C
Drawer/Door Base Cabinet Pullout
(11" version shown)



Adjustable threaded rub bushings included for custom applications

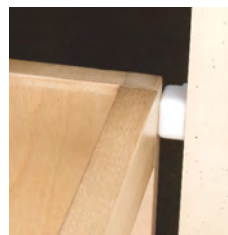

Plastic rub bushings included for 1.5" and 1.75" face frame applications



Waste

Blind Corner

Sink

Base

Tall

Drawer

Wall

Vanity

Closet

Lazy Susan

LED Lighting



SCAN FOR PRICING!



448-08SC-SRI-1
Spice Rack
(7" version shown)
Sold separately



448-BCSC-9C
Base Cabinet Pullout for Full Access
(9" version shown)



448-BCSC-8C
Base Cabinet Pullout for Full Height
(8" version shown)



448-BC19SC-5C
Base Cabinet Pullout, Reduced Depth
(5" version shown)

Minimum Cabinet Opening

PRODUCT #	MCO FF	MCOFL
448-BCSC-5C	5-1/2" (140 mm)	6" (152 mm)
448-BC19SC-5C	5-1/2" (140 mm)	6" (152 mm)
448-BCSC-8C	8-1/2" (216 mm)	9" (229 mm)
448-BC19SC-8C	8-1/2" (216 mm)	9" (229 mm)
448-BCSC-11C	11-1/2" (292 mm)	12" (305 mm)
448-BCSC-14C	14-1/2" (368 mm)	15" (381 mm)
448-BCSC-6C	7-1/2" (191 mm)	7-1/2" (191 mm)
448-BCSC-9C	10-1/2" (268 mm)	10-1/2" (268 mm)
448-BCSCSD-5C	5-1/2" (140 mm)	6" (152 mm)
448-BCSCSD-8C	8-1/2" (216 mm)	9" (229 mm)
448-BDDSC-5C	5-1/2" (140 mm)	6" (152 mm)
448-BDDSC-8C	8-1/2" (216 mm)	9" (229 mm)
448-BDDSC-11C	11-1/2" (292 mm)	12" (305 mm)



448-BCSCSD-5C
Base Cabinet Pullout w/ SERVO-DRIVE
(5" version shown)



448-BDDSC-11C
Base Cabinet Pullout for Drawer/Door
(11" version shown)

* Reduced depth

Base Cabinet Pullout w/ BLUMOTION Soft-Close for Full Height

PRODUCT	DESCRIPTION	DIMS	CAB	FINISH	SLP
448-BCSC-5C	Base Organizer	6" (152 mm) W x 21-5/8" (549 mm) D x 25-1/2" - 29-1/2" (648 - 749 mm) H	FHB9	Maple	\$422.55
448-BC19SC-5C	Base Organizer*	6" (152 mm) W x 19-9/16" (497 mm) D x 25-1/2" (648 mm) H	FHB9	Maple	\$415.85
448-BCSC-8C	Base Organizer	8-3/4" (222 mm) W x 21-5/8" (549 mm) D x 25-1/2" - 29-1/2" (648 - 749 mm) H	FHB12	Maple	\$469.95
448-BC19SC-8C	Base Organizer*	8-3/4" (222 mm) W x 19-9/16" (497 mm) D x 25-1/2" (648 mm) H	FHB12	Maple	\$538.25
448-BCSC-11C	Base Organizer	11-3/4" (298 mm) W x 21-5/8" (549 mm) D x 25-1/2" - 29-1/2" (648 - 749 mm) H	FHB15	Maple	\$554.75
448-BCSC-14C	Base Organizer	14-3/4" (375 mm) W x 21-5/8" (549 mm) D x 25-1/2" - 29-1/2" (648 - 749 mm) H	FHB18	Maple	\$685.85

Full Access Base Cabinet Pullout w/ BLUMOTION Soft-Close

448-BCSC-6C	Base Organizer	7-1/4" (184 mm) W x 21-5/8" (549 mm) D x 25-1/2" - 29-1/2" (648 - 749 mm) H	FLFHB9	Maple	\$450.35
448-BCSC-9C	Base Organizer	10-1/4" (260 mm) W x 21-5/8" (549 mm) D x 25-1/2" - 29-1/2" (648 - 749 mm) H	FLFHB12	Maple	\$530.25

Base Cabinet Pullout w/ BLUMOTION Soft-Close and SERVO-DRIVE

448-BCSCSD-5C	Base Organizer	6" (152 mm) W x 22-3/4" - 24-1/4" (578 - 616 mm) D x 25-1/2" - 29-1/2" (648 - 749 mm) H	FHB9	Maple	\$1249.90
448-BCSCSD-8C	Base Organizer	8-3/4" (222 mm) W x 22-3/4" - 24-1/4" (578 - 616 mm) D x 25-1/2" - 29-1/2" (648 - 749 mm) H	FHB12	Maple	\$1290.50

Base Cabinet Pullout w/ BLUMOTION Soft-Close for Drawer/Door

448-BDDSC-5C	Base Organizer	5-29/32" (150 mm) W x 21-5/8" (549 mm) D x 19-3/8" - 23-3/8" (493 - 594 mm) H	B9	Maple	\$364.40
448-BDDSC-8C	Base Organizer	8-3/4" (222 mm) W x 21-5/8" (549 mm) D x 19-3/8" - 23-3/8" (494 - 594 mm) H	B12	Maple	\$460.40
448-BDDSC-11C	Base Organizer	11-3/4" (298 mm) W x 21-5/8" (549 mm) D x 19-3/8" - 23-3/8" (494 - 594 mm) H	B15	Maple	\$529.10

Spice Rack Insert for Base Cabinet Pullout

448-08SC-SRI-1	Spice Rack	7" (178 mm) W x 19-7/16" (494 mm) D x 4-27/32" (124 mm) H	Maple	\$100.50
448-11SC-SRI-1	Spice Rack	10" (254 mm) W x 19-7/16" (494 mm) D x 4-27/32" (124 mm) H	Maple	\$116.15

Waste
Blind Corner
Sink
Base
Tall
Drawer
Wall
Vanity
Closet
Susan
Lazy
LED Lighting



SCAN FOR PRICING!



- Designed for 12" full height base cabinets
- Natural maple construction with semi-gloss finish
- Full-extension, BLUM soft-close undermount slides
- Patented mounting straps (US Patent No. 9,756,941)
- (7) BPA free OXO® Good Grips POP containers
 - (3) 4.3 qt.
 - (3) 1.7 qt.
 - (1) 2.6 qt.
- Adjustable rub bushings
- Patented door mount brackets provide 5" of adjustability and include micro-trim adjuster (US Patent No. 8,388,076)
- TSCA Title VI compliant



448OXO-BCSC-8C



448OXO-BCSC-8C
Base Cabinet Pullout w/ OXO® Containers



Adjustable threaded rub bushings included for custom applications



Plastic rub bushings included for 1.5" and 1.75" face frame applications



For video visit:
rev-a-shelf.com/videos

Minimum Cabinet Opening

PRODUCT #	MCO FF	MCO FL
448OXO-BCSC-8C	8-1/2" (216 mm)	9" (229 mm)

Base Cabinet Pullout w/ OXO® Containers and BLUMOTION Soft-Close

PRODUCT	DESCRIPTION	DIMS	CAB	FINISH	SLP
448OXO-BCSC-8C	Base Organizer	8-3/4" (222 mm) W x 21-5/8" (549 mm) D x 25-1/2" - 29-1/2" (648 - 749 mm) H	FHB12	Maple	\$944.10



SCAN FOR PRICING!

Base Cabinet Pullout w/ Utensil Bins

448UT Series



- Designed for 9" and 12" full height base cabinets
- Natural maple construction with semi-gloss finish
- Full-extension, BLUM soft-close undermount slides
- Patented mounting straps (US Patent No. 9,756,941)
- (3) 1.25 qt. or (3) 2 qt. stainless steel bins
- Adjustable shelves and rear wall for added stability
- Adjustable rub bushings that prevent side to side movement
- Patented door mount brackets provide 5" of adjustability and include micro-trim adjuster (US Patent No. 8,388,076)
- TSCA Title VI compliant

448UT-BCSC-8C



Adjustable threaded rub bushings included for custom applications

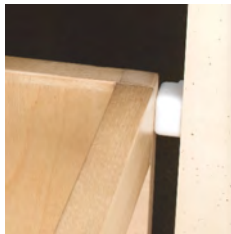

Plastic rub bushings included for 1.5" and 1.75" face frame applications



448UT-BCSC-5C
Base Cabinet Pullout
w/ Utensil Bins
(5" unit shown)

Minimum Cabinet Opening

PRODUCT #	MCO FF	MCO FL
448UT-BCSC-5C	5-1/2" (140 mm)	6" (152 mm)
448UT-BCSC-8C	8-1/2" (216 mm)	9" (229 mm)



For video visit:
rev-a-shelf.com/videos

Base Cabinet Pullout w/ (3) Utensil Bins and BLUMOTION Soft-Close

PRODUCT	DESCRIPTION	DIMS	CAB	FINISH	SLP
448UT-BCSC-5C	Base Organizer	6" (152 mm) W x 21-5/8" (549 mm) D x 25-1/2" - 29-1/2" (648 - 749 mm) H	FHB9	Maple	\$517.80
448UT-BCSC-8C	Base Organizer	8-3/4" (222 mm) W x 21-5/8" (549 mm) D x 25-1/2" - 29-1/2" (648 - 749 mm) H	FHB12	Maple	\$586.10



Waste
Blind Corner
Sink
Base
Tall
Drawer
Wall
Vanity
Closet
Lazy Susan
LED Lighting



SCAN FOR PRICING!

- Designed for 9", 12" and 15" full height face frame base cabinets, and 12" full height full access cabinets
- Natural maple construction with a semi-gloss finish
- Full-extension, BLUM soft-close undermount slides
- Patented mounting straps (US Patent No. 9,756,941)
- (1) 2 qt. or (1) 2 qt. and (3) 1.25 qt. removable stainless steel bins
- Knife block features flex rod technology that adjusts to securely hold knives
- (4) flexible plastic cutting mats
- Adjustable rear wall
- Adjustable accessory shelf and lower static shelf with chrome rails
- Patented door mount brackets provide 5" of adjustability and include micro-trim adjuster (US Patent No. 8,388,076)
- TSCA Title VI compliant



448KB-BCSC-5C



448KB-BCSC-8C
Base Cabinet Pullout w/ Knife Block and Utensil Bin (8" unit shown)



448KB-BCSC-11C
Base Cabinet Pullout w/ Knife Block and Utensil Bins (11" unit shown)



Now with flexible cutting mats



Adjustable threaded rub bushings included for custom applications

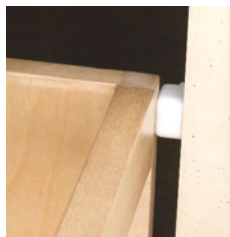

Plastic rub bushings included for 1-1/2" and 1-3/4" face frame applications



For video visit:
rev-a-shelf.com/videos

Minimum Cabinet Opening

PRODUCT #	MCO FF	MCO FL
448KB-BCSC-5C	5-1/2" (140 mm)	5-1/2" (140 mm)
448KB-BCSC-8C	8-1/2" (216 mm)	9" (229 mm)
448KB-BCSC-9C	10-1/2" (267 mm)	10-1/2" (267 mm)
448KB-BCSC-11C	11-1/2" (292 mm)	12" (305 mm)



Base Cabinet Pullout w/ Knife Block and Utensil Bins w/ BLUMOTION Soft-Close

PRODUCT	DESCRIPTION	DIMS	CAB	FINISH	SLP
448KB-BCSC-5C	Base Organizer w/ (1) Bin	6" (152 mm) W x 21-5/8" (549 mm) D x 25-1/2" (648 mm) H	FHB9	Maple	\$662.20
448KB-BCSC-8C	Base Organizer w/ (1) Bin	8-3/4" (222 mm) W x 21-5/8" (549 mm) D x 25-1/2" - 29-1/2" (648 - 749 mm) H	FHB12	Maple	\$766.45
448KB-BCSC-11C	Base Organizer w/ (4) Bins	11-3/4" (298 mm) W x 21-5/8" (549 mm) D x 25-1/2" - 29-1/2" (648 - 749 mm) H	FHB15	Maple	\$914.80

Full Access Base Cabinet Pullout w/ Knife Block and Utensil Bins w/ BLUMOTION Soft-Close

448KB-BCSC-9C	Base Organizer w/ (1) Bin	10-1/4" (260 mm) W x 21-5/8" (549 mm) D x 25-1/2" - 29-1/2" (648 - 749 mm) H	FLB12	Maple	\$854.65
---------------	---------------------------	--	-------	-------	----------



SCAN FOR PRICING!

Base Cabinet Pullout Tray Divider/Foil Wrap Holder

447 Series



- Designed for 9" and 12" base cabinets
- Natural maple construction with semi-gloss finish
- Full-extension, BLUM soft-close undermount slides
- Patented mounting straps (US Patent No. 9,756,941)
- Removable center T-Bar divider for taller items
- Patented door mount brackets provide 5" of adjustability and include micro-trim adjuster (US Patent No. 8,388,076)
- TSCA Title VI compliant

447-BCSC-8C

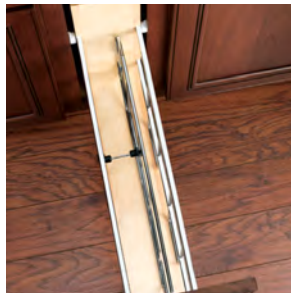

Included T-Bars allow you to customize your storage needs



447-BCSC-5C
Base Cabinet Pullout w/ Utensil Bins (5" unit shown)



Adjustable threaded rub bushings included for custom applications



Plastic rub bushings included for 1-1/2" and 1-3/4" face frame applications

Minimum Cabinet Opening

PRODUCT #	MCO FF	MCO FL
447-BCSC-5C	5-1/2" (140 mm)	6" (152 mm)
447-BCSC-8C	8-1/2" (216 mm)	9" (229 mm)

Base Cabinet Pullout Tray Divider/Foil Wrap Holder w/ BLUMOTION Soft-Close

PRODUCT	DESCRIPTION	DIMS	CAB	FINISH	SLP
447-BCSC-5C	Base Cabinet Pullout	6" (152 mm) W x 21-21/32" (550 mm) x 19-1/2" (495 mm) H	B9	Maple	\$413.70
447-BCSC-8C	Base Cabinet Pullout	8-3/4" (222 mm) W x 21-21/32" (550 mm) x 19-1/2" (495 mm) H	B12	Maple	\$474.00

Waste
Blind Corner
Sink
Base
Tall
Drawer
Wall
Vanity
Closet
Susan
Lazy
LED Lighting



SCAN FOR PRICING!



449KB-BCSC-8C



- Designed for 9" and 12" full height base cabinets
 - Face Frame fit 1-3/4", 1-1/2" and 1-5/8"
 - Full Access fit 3/4" and 5/8"
- Natural maple construction with semi-gloss finish
- (2) adjustable shelves for base organizer and (1) adjustable shelf for utensil organizer with chrome accents
- Utensil organizer features (3) 1.25 qt. removable stainless steel bins
- Full-extension, BLUM soft-close undermount slides
- Face frame version features patent-pending foldable slide set for easy installation
- Mounts to cabinet door, floor and side
- Patented foldable slide set for easy installation (US Patent No. 10,799,020)
- Patented door mount brackets provide 5" of adjustability and include micro-trim adjuster (US Patent No. 8,388,076)
- Patented design for 449, 449UT and 449KB 5C and 8C units (US Patent No. 10,799,020)
- TSCA Title VI compliant



For video visit:
rev-a-shelf.com/videos



SCAN FOR PRICING!



Full access slide location



Face frame slide location



Adjustable "L" bracket for side mount



Spacer allows for multiple face frame sizes



Patented face frame foldable slide set for easy installation

Patented design
(US Patent No. 10,799,020)



449KB-BCSC-8C
Side and Bottom Mount
Knife Block Base Pullout
(8" version shown)



449-BCSC-5C
Side and Bottom Mount
Base Pullout
(5" version shown)



449-BCSC-7C
Full Access Side and Bottom Mount
Base Pullout
(7" version shown)



449-BCSC-8C
Side and Bottom Mount
Base Pullout
(8" version shown)



449UT-BCSC-7C
Full Access Side and Bottom Mount
Utensil Base Pullout
(7" version shown)

Side and Bottom Mount Base Pullout w/ BLUMOTION Soft-Close

PRODUCT	DESCRIPTION	DIMS	MCO	CAB	FINISH	SLP
449-BCSC-5C	Base Organizer	6-1/4" (159 mm) W x 21-3/4" (552 mm) D x 25-9/16" (648 mm) H	5-1/2" (140 mm)	FHB9	Maple	\$492.85
449-BCSC-8C	Base Organizer	9-1/4" (235 mm) W x 21-3/4" (552 mm) D x 25-9/16" (648 mm) H	8-1/2" (216 mm)	FHB12	Maple	\$576.25

Full Access Side and Bottom Mount Base Pullout w/ BLUMOTION Soft-Close

449-BCSC-7C	Base Organizer	7-1/2" (190 mm) W x 21-3/4" (554 mm) D x 25-1/4" (641 mm) H	7-1/2" (191 mm)	FLFHB9	Maple	\$477.20
449-BCSC-10C	Base Organizer	10-1/2" (267 mm) W x 21-3/4" (554 mm) D x 25-1/4" (641 mm) H	10-1/2" (267 mm)	FLFHB12	Maple	\$580.30

Side and Bottom Mount Utensil Base Pullout w/ BLUMOTION Soft-Close

449UT-BCSC-5C	Utensil Organizer	6-1/4" (159 mm) W x 21-3/4" (552 mm) D x 25-9/16" (648 mm) H	5-1/2" (140 mm)	FHB9	Maple	\$521.25
449UT-BCSC-8C	Utensil Organizer	9-1/4" (235 mm) W x 21-3/4" (552 mm) D x 25-9/16" (648 mm) H	8-1/2" (216 mm)	FHB12	Maple	\$620.60

Full Access Side and Bottom Mount Utensil Base Pullout w/ BLUMOTION Soft-Close

449UT-BCSC-7C	Utensil Organizer	7-1/2" (190 mm) W x 21-3/4" (554 mm) D x 25-1/4" (641 mm) H	7-1/2" (191 mm)	FLFHB9	Maple	\$512.55
449UT-BCSC-10C	Utensil Organizer	10-1/2" (267 mm) W x 21-3/4" (554 mm) D x 25-1/4" (641 mm) H	10-1/2" (267 mm)	FLFHB12	Maple	\$605.80

Side and Bottom Mount Knife Block Base Pullout w/ BLUMOTION Soft-Close

449KB-BCSC-8C	Base Organizer w/ (1) Bin	9-1/4" (236 mm) W x 21-3/4" (552 mm) D x 25-9/16" (650 mm) H	8-1/2" (216 mm)	FHB12	Maple	\$776.60
---------------	---------------------------	--	-----------------	-------	-------	----------

Waste
Blind Corner
Sink
Base
Tall
Drawer
Wall
Vanity
Closet
Susan
Lazy
LED
Lighting



SCAN FOR PRICING!



- Designed for 9", 12" and 15" face frame base cabinets and 9" and 12" full access base cabinets
- Solid bottom shelves with chrome-plated round wire, gray or natural maple or orion gray flat wire with textured linen finish
- Full-extension, BLUM soft-close undermount slides
- 5322-BCSC-5 mounts to cabinet side wall
- 5322-BCSC-8 and 11 mount to cabinet floor
- Patented door mount brackets (US Patent No. 8,047,621)
- TSCA Title VI compliant

5322-BCSC-9-FOG



Minimum Cabinet Opening

PRODUCT #	MCO FF	MCO FL
5322-BCSC-6-GR	7" (178 mm)	7-1/2" (191 mm)
5322-BCSC-6-MP	7" (178 mm)	7-1/2" (191 mm)
5322-BCSC-9-GR	10" (254 mm)	10-1/2" (268 mm)
5322-BCSC-9-MP	10" (254 mm)	10-1/2" (268 mm)
5322-BCSC-6-FOG	7" (178 mm)	7-1/2" (191 mm)
5322-BCSC-9-FOG	10" (254 mm)	10-1/2" (268 mm)
5322-BCSC-5-GR	6" (152 mm)	6" (152 mm)
5322-BCSC-5-MP	6" (152 mm)	6" (152 mm)
5322-BCSC-8-GR	8-1/2" (216 mm)	9" (229 mm)
5322-BCSC-8-MP	8-1/2" (216 mm)	9" (229 mm)
5322-BCSC-11-GR	11-1/2" (292 mm)	12" (305 mm)
5322-BCSC-11-MP	11-1/2" (292 mm)	12" (305 mm)



For video visit:
rev-a-shelf.com/videos



SCAN FOR PRICING!

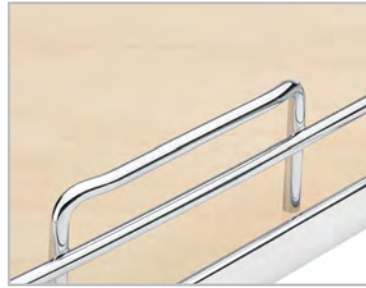

Solid bottom shelves in maple or gray, with chrome accents or orion gray with flat wire



Features Rev-A-Shelf's patented AMB door mount brackets (US Patent No. 8,047,621)



5322-BCSC-5-MP
Face Frame
Contemporary Base Cabinet Pullout
(5" Maple version shown)
(Side mount only)



5322-BCSC-11-GR
Contemporary Base Cabinet Pullout
w/ Soft-Close
(11" Gray version shown)



5322-BCSC-6-FOG
Contemporary Base Cabinet Pullout
(6" Orion Gray version shown)

Full Access Contemporary Base Cabinet Pullout w/ BLUMOTION Soft-Close

PRODUCT	DESCRIPTION	DIMS	CAB	FINISH	SLP
5322-BCSC-6-GR	Base Organizer	7-1/4" (184 mm) W x 21-11/16" (551 mm) D x 24-1/4" (616 mm) H	FLFHB9	Gray	\$521.15
5322-BCSC-6-MP	Base Organizer	7-1/4" (184 mm) W x 21-11/16" (551 mm) D x 24-1/4" (616 mm) H	FLFHB9	Maple	\$528.50
5322-BCSC-9-GR	Base Organizer	10-1/4" (260 mm) W x 21-11/16" (551 mm) D x 24-1/4" (616 mm) H	FLFHB12	Gray	\$537.65
5322-BCSC-9-MP	Base Organizer	10-1/4" (260 mm) W x 21-11/16" (551 mm) D x 24-1/4" (616 mm) H	FLFHB12	Maple	\$544.60
5322-BCSC-6-FOG	Base Organizer	7-1/4" (184 mm) W x 21-11/16" (551 mm) D x 24-1/4" (616 mm) H	FLFHB9	Orion Gray	\$572.60
5322-BCSC-9-FOG	Base Organizer	10-1/4" (260 mm) W x 21-11/16" (551 mm) D x 24-1/4" (616 mm) H	FLFHB12	Orion Gray	\$583.20

Face Frame Contemporary Base Cabinet Pullout w/ BLUMOTION Soft-Close

5322-BCSC-5-GR	Base Organizer	6" (152 mm) W x 22-1/8" (562 mm) D x 24-1/2" (622 mm) H	FFFHB9	Gray	\$485.75
5322-BCSC-5-MP	Base Organizer	6" (152 mm) W x 22-1/8" (562 mm) D x 24-1/2" (622 mm) H	FFFHB9	Maple	\$493.30
5322-BCSC-8-GR	Base Organizer	8-3/4" (222 mm) W x 21-11/16" (551 mm) D x 24-1/2" (622 mm) H	FFFHB12	Gray	\$576.10
5322-BCSC-8-MP	Base Organizer	8-3/4" (222 mm) W x 21-11/16" (551 mm) D x 24-1/2" (622 mm) H	FFFHB12	Maple	\$585.20
5322-BCSC-11-GR	Base Organizer	11-3/4" (299 mm) W x 21-11/16" (551 mm) D x 24-1/2" (622 mm) H	FFFHB15	Gray	\$606.70
5322-BCSC-11-MP	Base Organizer	11-3/4" (299 mm) W x 21-11/16" (551 mm) D x 24-1/2" (622 mm) H	FFFHB15	Maple	\$613.05



SCAN FOR PRICING!



5322KB-BCSC-6-FOG



- Designed for 9" full access cabinets and 12" and 15" full access and face frame base cabinets
- Solid bottom shelves with chrome-plated round wire, gray or natural maple or orion gray flat wire and textured linen finish
- Full-extension, BLUM soft-close undermount slides
- (1) 2 qt. or (2) 2 qt. and (2) 1.25 qt. removable stainless steel bins
- Patented door mount brackets (US Patent No. 8,047,621)
- Knife block features flex rod technology that adjusts to securely hold knives
- TSCA Title VI compliant

Minimum Cabinet Opening

PRODUCT #	MCO FF	MCO FL
5322KB-BCSC-6-GR	7" (178 mm)	7-1/2" (191 mm)
5322KB-BCSC-6-MP	7" (178 mm)	7-1/2" (191 mm)
5322KB-BCSC-9-GR	10" (254 mm)	10-1/2" (267 mm)
5322KB-BCSC-9-MP	10" (254 mm)	10-1/2" (267 mm)
5322KB-BCSC-6-FOG	7" (178 mm)	7-1/2" (191 mm)
5322KB-BCSC-8-GR	8-1/2" (216 mm)	9" (229 mm)
5322KB-BCSC-8-MP	8-1/2" (216 mm)	9" (229 mm)
5322KB-BCSC-11-GR	11-1/2" (292 mm)	12" (305 mm)
5322KB-BCSC-11-MP	11-1/2" (292 mm)	12" (305 mm)



For video visit:
rev-a-shelf.com/videos



SCAN FOR PRICING!

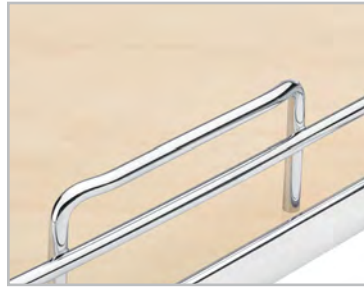

Solid bottom shelves in maple or gray, with chrome accents or orion gray with flat wire



Features Rev-A-Shelf's patented AMB door mount brackets (US Patent No. 8,047,621)



5322KB-BCSC-6-MP
Face Frame
Contemporary Base Cabinet Pullout
w/ Knife Block and Utensil Bin
(6" Maple version shown)



5322KB-BCSC-11-GR
Contemporary Base Cabinet Pullout
w/ Knife Block and Utensil Bins
(11" Gray version shown)



5322KB-BCSC-6-FOG
Contemporary Base Cabinet Pullout
w/ Knife Block and Utensil Bin
(6" Orion Gray version shown)

Full Access Contemporary Base Cabinet Pullout w/ BLUMOTION Soft-Close

PRODUCT	DESCRIPTION	DIMS	CAB	FINISH	SLP
5322KB-BCSC-6-GR	Base Organizer w/ (1) Bin	7-1/4" (184 mm) W x 21-11/16" (551 mm) D x 24-1/4" (616 mm) H	FLFHB9	Gray	\$972.65
5322KB-BCSC-6-MP	Base Organizer w/ (1) Bin	7-1/4" (184 mm) W x 21-11/16" (551 mm) D x 24-1/4" (616 mm) H	FLFHB9	Maple	\$979.90
5322KB-BCSC-9-GR	Base Organizer w/ (1) Bin	10-1/4" (260 mm) W x 21-11/16" (551 mm) D x 24-1/4" (616 mm) H	FLFHB12	Gray	\$993.85
5322KB-BCSC-9-MP	Base Organizer w/ (1) Bin	10-1/4" (260 mm) W x 21-11/16" (551 mm) D x 24-1/4" (616 mm) H	FLFHB12	Maple	\$1000.80
5322KB-BCSC-6-FOG	Base Organizer w/ (1) Bin	7-1/4" (184 mm) W x 21-11/16" (551 mm) D x 24-1/4" (616 mm) H	FLFHB9	Orion Gray	\$911.30

Face Frame Contemporary Base Cabinet Pullout w/ BLUMOTION Soft-Close

5322KB-BCSC-8-GR	Base Organizer w/ (1) Bin	8-3/4" (222 mm) W x 21-11/16" (551 mm) D x 24-1/4" (616 mm) H	FFFHB12	Gray	\$884.50
5322KB-BCSC-8-MP	Base Organizer w/ (1) Bin	8-3/4" (222 mm) W x 21-11/16" (551 mm) D x 24-1/4" (616 mm) H	FFFHB12	Maple	\$905.40
5322KB-BCSC-11-GR	Base Organizer w/ (4) Bins	11-3/4" (299 mm) W x 21-11/16" (551 mm) D x 24-1/4" (616 mm) H	FFFHB15	Gray	\$971.95
5322KB-BCSC-11-MP	Base Organizer w/ (4) Bins	11-3/4" (299 mm) W x 21-11/16" (551 mm) D x 24-1/4" (616 mm) H	FFFHB15	Maple	\$981.80



SCAN FOR PRICING!



5322UT-BCSC-6-FOG



- Designed for 12" base cabinets
- Solid bottom shelves with chrome-plated round wire, gray or natural maple or orion gray flat wire and textured linen finish
- Full-extension, BLUM soft-close undermount slides
- (3) 2 qt. or (3) 1.25 qt. removable stainless steel bins
- Patented door mount brackets (US Patent No. 8,047,621)
- TSCA Title VI compliant

Minimum Cabinet Opening

PRODUCT #	MCO FF	MCO FL
5322UT-BCSC-6-GR	7" (178 mm)	7-1/2" (191 mm)
5322UT-BCSC-6-MP	7" (178 mm)	7-1/2" (191 mm)
5322UT-BCSC-6-FOG	7" (178 mm)	7-1/2" (191 mm)
5322UT-BCSC-8-GR	8-1/2" (216 mm)	9" (229 mm)
5322UT-BCSC-8-MP	8-1/2" (216 mm)	9" (229 mm)



For video visit:
rev-a-shelf.com/videos

Waste

Blind Corner

Sink

Base

Tall

Drawer

Wall

Vanity

Closet

Lazy Susan

LED Lighting



SCAN FOR PRICING!



Solid bottom shelves in maple or gray, with chrome accents or orion gray with flat wire



Features Rev-A-Shelf's patented AMB door mount brackets (US Patent No. 8,047,621)



5322UT-BCSC-8-MP
Face Frame
Contemporary Base Cabinet
Pullout w/ Utensil Bins
(8" Maple version shown)



5322UT-BCSC-8-GR
Contemporary Base Cabinet
Pullout w/ Utensil Bins
(8" Gray version shown)



5322UT-BCSC-6-FOG
Contemporary Base Cabinet
Pullout w/ Utensil Bins
(6" Orion Gray version shown)

Full Access Contemporary Base Cabinet Pullout w/ (3) Utensil Bins and BLUMOTION Soft-Close

PRODUCT	DESCRIPTION	DIMS	CAB	FINISH	SLP
5322UT-BCSC-6-GR	Base Organizer	7-1/4" (184 mm) W x 21-11/16" (551 mm) D x 24-1/4" (610 mm) H	FLFHB9	Gray	\$635.80
5322UT-BCSC-6-MP	Base Organizer	7-1/4" (184 mm) W x 21-11/16" (551 mm) D x 24-1/4" (610 mm) H	FLFHB9	Maple	\$646.70
5322UT-BCSC-6-FOG	Base Organizer	7-1/4" (184 mm) W x 21-11/16" (551 mm) D x 24-1/4" (610 mm) H	FLFHB9	Orion Gray	\$663.80

Face Frame Contemporary Base Cabinet Pullout w/ (3) Utensil Bins and BLUMOTION Soft-Close

5322UT-BCSC-8-GR	Base Organizer	8-3/4" (221 mm) W x 21-11/16" (551 mm) D x 24-1/4" (610 mm) H	FFFHB12	Gray	\$667.15
5322UT-BCSC-8-MP	Base Organizer	8-3/4" (221 mm) W x 21-11/16" (551 mm) D x 24-1/4" (610 mm) H	FFFHB12	Maple	\$676.40



SCAN FOR PRICING!



- Designed for a 15" minimum cabinet opening
- Chrome-plated round wire
- Gas spring assist soft-open/soft-close
- Holds (20) wine bottles, 150 lb. capacity
- Universal for left or right handed cabinets



5375-40WR-1CR



5375-40WR-1CR
Wine Base Cabinet Pullout



Wine Base Organizer w/ Soft-Close

PRODUCT	DESCRIPTION	DIMS	MCO	CAB	FINISH	SLP
5375-40WR-1CR	Wine Base Organizer	14-1/8" (359 mm) W x 17" (432 mm) D x 25-3/4" (654 mm) H	15" (381 mm) - FF 15" (381 mm) - FL	FHB18	Chrome	\$795.30



SCAN FOR PRICING!

Chrome Base Pullout

5225 Series



- Designed for 12" base cabinets
- Solid bottom shelves with chrome-plated round wire and Stylinox™ anti-skid, maple
- Full-extension, 250 lb. rated slides with soft-close
- Built-in door mount brackets included
- TSCA Title VI compliant



Chrome Base Pullout w/ (3) Maple Shelves

PRODUCT	DESCRIPTION	DIMS	MCO	CAB	FINISH	SLP
5225-09-MP	Chrome Base Pullout	8-5/8" (219 mm) W x 19-1/2" (495 mm) D x 26-3/4" (680 mm) - 35" (889 mm) H	9" (229 mm)	FHB12	Maple	\$1092.60

Chrome Base Pullout

548 Series



- Designed for use in both 12" full height or drawer/door cabinet applications
- (2) adjustable polymer shelves with chrome accents
- Ball-bearing, patented tri-slide system
- Patented door mounting system (US Patent No: 7,204,569)

Chrome Base Pullout w/ (3) Polymer Shelves

PRODUCT	DESCRIPTION	DIMS	MCO	CAB	FINISH	SLP
548-BC-8C	Chrome Base Pullout	7-29/32" (201 mm) W x 22-1/2" (572 mm) D x 19-5/16" (491 mm) H	7-29/32" (201 mm)	B12	Chrome	\$274.90

Waste
Blind Corner
Sink
Base
Tall
Drawer
Wall
Vanity
Closet
Susan
LED Lighting



SCAN FOR PRICING!



- Designed for 15", 18", 24" and 36" base cabinets
- Chrome-plated round wire
- Full-extension, under mount slides with soft-close
- Adjustable mounting brackets
- Door mount brackets included

5730-21CR

Minimum Cabinet Opening

PRODUCT #	MCO FF	MCO FL
5730-12CR	11-1/2" (292 mm)	11-1/2" (292 mm)
5730-15CR	14-1/2" (368 mm)	14-1/2" (368 mm)
5730-21CR	20-1/2" (521 mm)	20-1/2" (521 mm)
5730-33CR	32-1/2" (826 mm)	32-1/2" (826 mm)



SCAN FOR PRICING!

MOUNTING BRACKET OPTIONS

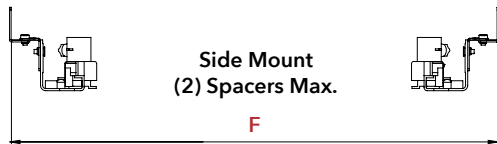
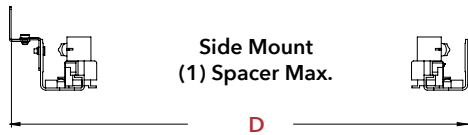
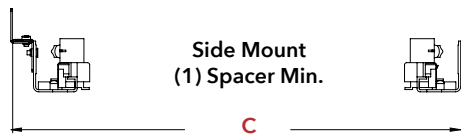
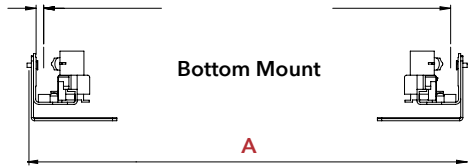

Create a customized space for pots, pans and lids with the new Chrome Wire Drop In Cookware Organizer, compatible with 21" and 33" pullout shelves



5730-12CR
Pullout Wire Shelf
(12" version shown)



5730-15CR
Pullout Wire Shelf
(15" version shown)

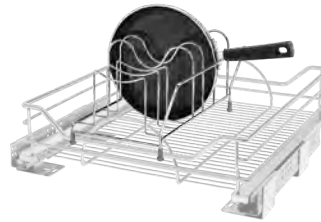

5730-21CR
Pullout Wire Shelf
(21" version shown)

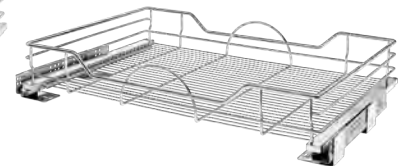

5730-33CR
Pullout Wire Shelf
(33" version shown)

PART	A	B	C	D	E	F
5730-12CR	11-15/16" (303 mm)	11-1/2" (292 mm)	12-5/16" (313 mm)	12-11/16" (322 mm)	13-1/8" (333 mm)	13-7/8" (352 mm)
5730-15CR	14-15/16" (379 mm)	14-1/2" (368 mm)	15-5/16" (389 mm)	15-11/16" (399 mm)	16-1/8" (410 mm)	16-7/8" (429 mm)
5730-21CR	20-15/16" (532 mm)	20-1/2" (521 mm)	21-5/16" (541 mm)	21-11/16" (551 mm)	22-1/8" (562 mm)	22-7/8" (581 mm)
5730-33CR	32-15/16" (837 mm)	32-1/2" (826 mm)	33-5/16" (846 mm)	33-11/16" (856 mm)	34-1/8" (867 mm)	34-7/8" (886 mm)

Pullout Wire Shelf w/ Soft-Close slides

PRODUCT	DESCRIPTION	DIMS	CAB	FINISH	SLP
5730-12CR	Pullout Wire Shelf	11-1/2" (292 mm) W x 21-3/4" (553 mm) D x 5-3/16" (132 mm) H	B15	Chrome	\$317.10
5730-15CR	Pullout Wire Shelf	14-1/2" (368 mm) W x 21-3/4" (553 mm) D x 5-3/16" (132 mm) H	B18	Chrome	\$327.85
5730-21CR	Pullout Wire Shelf	20-1/2" (521 mm) W x 21-3/4" (553 mm) D x 5-3/16" (132 mm) H	B24	Chrome	\$349.45
5730-33CR	Pullout Wire Shelf	32-1/2" (826 mm) W x 21-3/4" (553 mm) D x 5-3/16" (132 mm) H	B36	Chrome	\$381.95

Accessories

5789CR	Drop In Cookware Organizer	14-1/16" (357 mm) W x 9-1/2" (241 mm) D x 7-11/16" (195 mm) H	Chrome	\$64.10
--------	----------------------------	---	--------	---------

Waste
Blind Corner
Sink
Base
Tall
Drawer
Wall
Vanity
Closet
Susan
Lazy
LED Lighting



SCAN FOR PRICING!



- Designed for 15", 18", 24" and 36" base cabinets
- Solid bottom shelves with chrome-plated wire, gray or natural maple, or orion gray flat wire with satin solid bottom
- Full-extension, BLUM soft-close undermount slides
- Side and bottom mounting brackets
- Door mounting brackets included
- TSCA Title VI compliant

5330-33BCSC-MP



Minimum Cabinet Opening

PRODUCT #	MCO FF	MCO FL
5330-12BCSC-**	11-1/2" (292 mm)	11-1/2" (292 mm)
5330-15BCSC-**	14-1/2" (368 mm)	14-1/2" (368 mm)
5330-21BCSC-**	20-1/2" (521 mm)	20-1/2" (521 mm)
5330-33BCSC-**	32-1/2" (826 mm)	32-1/2" (826 mm)
5330-33BCSCFL-FOG	32-1/2" (826 mm)	32-1/2" (826 mm)



For video visit:
rev-a-shelf.com/videos



SCAN FOR PRICING!

MOUNTING BRACKET OPTIONS

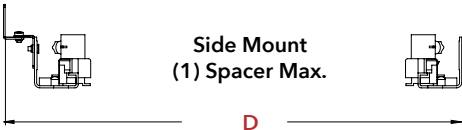
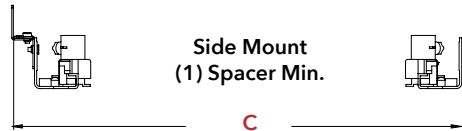
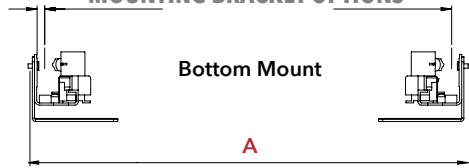

Solid bottom shelves in maple or gray, with chrome accents or orion gray with flat wire



5330-12BCSC-GR
Solid Bottom Shelf
(12" version shown)



5330-15BCSC-MP
Solid Bottom Shelf
(15" version shown)



5330-21BCSC-MP
Solid Bottom Shelf
(21" version shown)



5330-33BCSCFL-FOG
Solid Bottom Shelf
(33" version shown)

NOTE: ** Insert "MP" for Maple Shelf or "GR" for Gray Shelf

PART	A	B	C	D	E	F
5330-12BCSC-**	12-1/8" (308 mm)	11-11/16" (300 mm)	12-1/2" (318 mm)	12-7/8" (327 mm)	13-5/16" (338 mm)	14-1/16" (357 mm)
5330-15BCSC-**	15-1/8" (384 mm)	14-11/16" (373 mm)	15-1/2" (394 mm)	15-7/8" (403 mm)	16-5/16" (414 mm)	17-1/16" (433 mm)
5330-21BCSC-**	21-1/8" (537 mm)	20-11/16" (526 mm)	21-1/2" (546 mm)	21-7/8" (556 mm)	22-5/16" (567 mm)	23-1/16" (586 mm)
5330-33BCSC-**	33-1/8" (841 mm)	32-11/16" (830 mm)	33-1/2" (851 mm)	33-7/8" (860 mm)	34-5/16" (872 mm)	35-1/16" (891 mm)
5330-33BCSCFL-FOG	33-1/8" (841 mm)	32-11/16" (830 mm)	33-1/2" (851 mm)	33-7/8" (860 mm)	34-5/16" (872 mm)	35-1/16" (891 mm)

Face Frame Solid Bottom Pullout Shelf w/ BLUMOTION Soft-Close

PRODUCT	DESCRIPTION	DIMS	MCO	CAB	FINISH	SLP
5330-12BCSC-**	Solid Bottom Shelf	11-11/16" (300 mm) W x 21-17/32" (547 mm) D x 5-1/16" (129 mm) H	11-11/16" (300 mm)	FFB15	Chrome	\$496.05
5330-15BCSC-**	Solid Bottom Shelf	14-11/16" (373 mm) W x 21-17/32" (547 mm) D x 5-1/16" (129 mm) H	14-11/16" (373 mm)	FFB18	Chrome	\$506.50
5330-21BCSC-**	Solid Bottom Shelf	20-11/16" (526 mm) W x 21-17/32" (547 mm) D x 5-1/16" (129 mm) H	20-11/16" (526 mm)	FFB24	Chrome	\$539.25
5330-33BCSC-**	Solid Bottom Shelf	32-11/16" (830 mm) W x 21-17/32" (547 mm) D x 5-1/16" (129 mm) H	32-11/16" (830 mm)	FFB36	Chrome	\$572.30

Full Access Solid Bottom Pullout Shelf w/ BLUMOTION Soft-Close

5330-33BCSCFL-FOG	Solid Bottom Shelf	32-11/16" (830 mm) W x 21-17/32" (547 mm) D x 5-1/16" (129 mm) H	32-1/2" (826 mm) - FF 32-11/16" (830 mm) - FL	FLB36	Orion Gray	\$477.75
-------------------	--------------------	--	--	-------	------------	----------



SCAN FOR PRICING!



ML-WNHDSCOG-18FL

RAS-ML Series

- Fits most cabinet sizes
- Works with your custom shelf
- Mounts to cabinet side (face frame cabinets require spacers to flush sides to opening)
- Adjustable spring tension
- Available with built-in shock dampeners
- Holds appliances up to 60 lbs.

ML Series

- Silver lift:
 - Designed for 18" full height, face frame base cabinets
 - 1-3/8" thick maple shelf
- Orion gray lift:
 - Designed for 18" full height, full access base cabinets
 - 1-3/8" thick walnut shelf
- Mounts to cabinet side
- Adjustable spring tension
- Built-in shock dampeners
- Holds appliances up to 60 lbs.
- TSCA Title VI compliant



For video visit:
rev-a-shelf.com/videos



SCAN FOR PRICING!

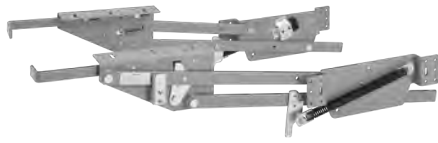

RAS-ML-HDCR
Mixer Lift
(Metallic Silver finish shown)

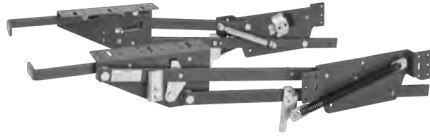

RAS-ML-HDSCOG
Soft-Close Mixer Lift
(Orion gray finish shown)

RECOMMENDED SPRING POSITION FOR VARYING MIXER WEIGHT

- 0-20 lb. = 1
- 20-30 lb. = 2
- 30-60 lb. = 3



Soft-Close piston



Great for a variety of small appliances

SOFT-CLOSE MIXER LIFT KITS W/ SHELF INCLUDED MIXER CLEARING DIMENSIONS

ML-MPHDSCCR-18
Soft-Close Mixer Lift Kit
(Maple/Metallic Silver finish shown)

ML-WNHDSOCG-18FL
Soft-Close Mixer Lift Kit
(Walnut/Orion Gray finish shown)

Shelf Dimensions
Maple (face frame): 11-3/4" (298 mm) W x 20" (508 mm) D x 1-3/8" (35 mm) H
Walnut (full access): 13-1/4" (336 mm) W x 20" (508 mm) D x 1-3/8" (35 mm) H
Note: Shelves are only sold in kits with the mixer lift.

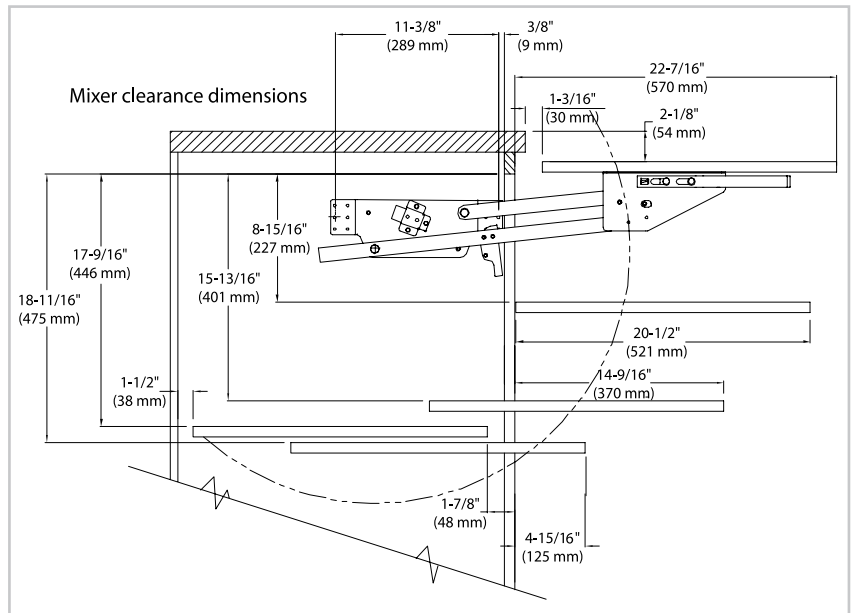

NOTE: To determine shelf size measure the distance between mounting plates when installed minus 1-1/4" (32 mm). Recommended length of shelf is 20" (508 mm). Mounting plates are 1" wide.

Heavy Duty Mixer Lift Kit w/ Soft-Close

PRODUCT	DESCRIPTION	DIMS	MCO	CAB	FINISH	SLP
ML-MPHDSCCR-18	Mixer Lift Kit	See Illustration	15" (381 mm)	FFFHB18	Metallic Silver/Maple	\$526.50
ML-WNHDSOCG-18FL	Mixer Lift Kit	See Illustration	16-1/2" (419 mm)	FLFHB18	Orion Gray	\$770.25

Heavy Duty Mixer Lift w/ Soft-Close - Arms Only

RAS-ML-HDSCOG	Mixer Lift	See Illustration			Orion Gray	\$377.70
RAS-ML-HDSC	Mixer Lift	See Illustration			Metallic Silver	\$377.70

Heavy Duty Mixer Lift

RAS-ML-HDCR	Mixer Lift	See Illustration			Metallic Silver	\$206.65
-------------	------------	------------------	--	--	-----------------	----------

Waste
Blind Corner
Sink
Base
Tall
Drawer
Wall
Vanity
Closet
Susan
Lazy
LED Lighting