



# Cabinet Knob & Pull Collections

2022

The Finishing Touch That Makes A Statement

Alvar.....	2-3	Leyton.....	48-49
Annadale.....	4-5	Lyon.....	47
Anwick.....	6-7	Marie.....	50-51
Audrey <b>NEW</b> .....	8-9	Marlo.....	52-53
Belcastel 1.....	10-11	Merrick.....	54-55
Bella.....	12	Milan 1.....	56-57
Bordeaux.....	13	Mirada.....	58-59
Boswell.....	14-15	Philip.....	60-61
Bremen 1.....	16-17	Rae.....	62-63
Bremen 2.....	18-19	Regan.....	66
Cairo.....	20-21	Renzo <b>NEW</b> .....	64-65
Callie.....	22-23	Roman.....	68-69
Carmen.....	24-25	Royce.....	67
Cordova.....	26	Sonoma.....	70-71
Delgado.....	27	Sullivan.....	72-73
Delmar.....	28	Sutton.....	74-75
Dominique.....	30-31	Tahoe.....	76-77
Durham.....	29	Tiffany.....	78-79
Elara.....	32-33	Wheeler.....	80-81
Ella.....	34-35	Zane.....	82-83
Harlow.....	36-37		
Hayworth.....	38-39		
Hudson.....	40		
Katharine.....	41		
Key Grande <b>NEW FINISHES</b> .....	42-43		
Key West & Key Largo.....	44-45		
Lafayette.....	46		

Aiden.....	86-87
Asher.....	85
Belfast.....	88
Brenton.....	89
Cosgrove.....	90
Edgefield.....	92-93
Florence.....	91
Gibson.....	94-95
Glendale.....	98
Hadly.....	96-97
Hammond.....	99
Kenner.....	102
Knox.....	100-101
Madison.....	103
Merryville.....	104
Naples <b>NEW FINISH</b> .....	106-109
Park.....	105
Seaver.....	110
Sedona.....	111
Slade.....	112
Somerset.....	113
Stanton.....	114-115
Strickland.....	116
Thatcher.....	118-119
Torino.....	117
Watervale.....	120
Zachary.....	121

Each Jeffrey Alexander and Elements item in this catalog has been marked with a letter code. The letter by each item corresponds to a price range for that item's suggested retail price. For the exact price on any item, please visit [www.HardwareResources.com](http://www.HardwareResources.com)

Projection	Inner Box	Price Code
1-1/16"	20	[D]
1-1/16"	20	[E]
1-1/16"	20	[E]
1-1/16"	10	[F]
1-1/16"	10	[G]

Label	Price Range
[A]	Under \$3.50
[B]	~\$3.50 – \$5.00
[C]	~\$5.00 – \$6.00
[D]	~\$6.00 – \$8.50
[E]	~\$8.50 – \$10.75
[F]	~\$10.75 – \$14.50
[G]	~\$14.50 – \$18.00
[H]	~\$18.00 – \$23.75
[J]	~\$23.75 – \$31.00
[K]	See Sales Associate

Price range subject to change. Please contact your sales representative to ensure you have the most recent price range.



This catalog features a selection of our Jeffrey Alexander and Elements knob and pull collections. Please visit [www.HardwareResources.com/decorative-hardware](http://www.HardwareResources.com/decorative-hardware) for our complete offering.



## A step above...in Quality, Selection, & Design

### **Quality**

All our products are manufactured from the highest quality materials and undergo meticulous examination to ensure only the best products reach your door. We believe strongly in the quality, integrity, and reliability of our products and offer a lifetime warranty on all Jeffrey Alexander decorative hardware.

### **Selection**

Jeffrey Alexander offers 60+ patented and original collections plus a variety of industry standard designs in a wide range of styles and finishes. With extended lengths as well as appliance handles available in many of our collections, there's something for everyone.

### **Designs**

Inspiration comes from the latest styles in interior design to the newest fashion trends on the runway. That inspiration is creatively transformed into beautiful hardware for any kitchen, bath, or home project. Our designs are heavier in weight with solid or flat backs, not hollow backs, adding a touch of luxury while providing a comfortable feel in your hand.



## Graceful

Alvar's graceful yet straightforward and contemporary curved profile is sure to enchant. With a variety of lengths and finishes, this pull collection blends well with raised panel, flat panel, and shaker-style cabinets.



Shown in Polished Nickel



Pulls	Center-to-Center	Overall Length	Foot Width x Length	Projection	Inner Box	Price Code
264-3	3" CC	3-11/16"	3/8" x 5/8"	1-1/16"	20	[D]
264-96	96 mm (3-3/4") CC	4-7/16"	3/8" x 5/8"	1-1/16"	20	[E]
264-128	128 mm (5-1/16") CC	5-3/4"	3/8" x 5/8"	1-1/16"	20	[E]
264-160	160 mm (6-5/16") CC	7"	3/8" x 5/8"	1-1/16"	10	[F]
264-192	192 mm (7-9/16") CC	8-1/4"	3/8" x 5/8"	1-1/16"	10	[G]

## Finishes



**BNBDL**  
Brushed Pewter



**DBAC**  
Brushed Oil  
Rubbed Bronze



**MB**  
Matte Black



**NI**  
Polished Nickel



**PC**  
Polished Chrome



**SBZ**  
Satin Bronze



**SN**  
Satin Nickel

# Annadale

US Patent #  
D708,040; D708,926; D721,941; D711,722



Knobs	Description	Overall Length	Foot Width x Length	Projection	Inner Box	Price Code
435	square knob	1-1/4"	3/4" x 3/4"	1-1/4"	20	[F]
435L	rectangle knob	1-1/2"	3/4" x 3/4"	1-1/4"	20	[F]

Pulls	Center-to-Center	Overall Length	Foot Width x Length	Projection	Inner Box	Price Code
435-96	96 mm (3-3/4") CC	5"	1-1/4" x 1"	1-1/8"	10	[G]
436-96	96 mm (3-3/4") CC cup pull	5"	1-1/4" x 5"	1-1/8"	10	[H]
435-128	128 mm (5-1/16") CC	6-1/4"	1-1/4" x 1"	1-3/16"	10	[J]
436-128	128 mm (5-1/16") CC cup pull	6-1/4"	1-1/4" x 6-1/4"	1-3/16"	10	[K]
435-160	160 mm (6-5/16") CC	7-9/16"	1-1/4" x 1"	1-3/16"	10	[K]

## Finishes





Shown in Brushed Oil Rubbed Bronze

## Inviting

A wide square shape softened with a pillow top accent makes Annadale an inviting and strikingly beautiful choice. Standard pulls and cup pulls are available to add the finishing touch to shaker cabinets.

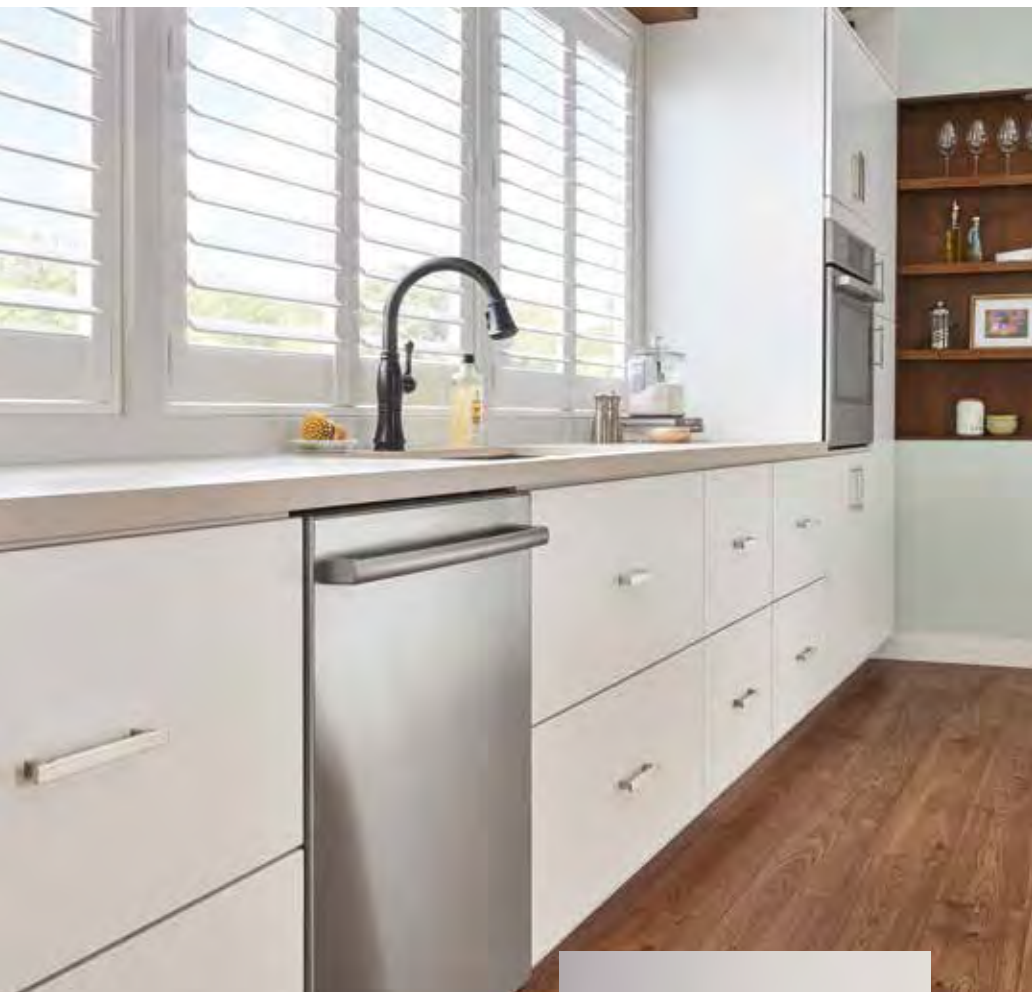

## Modern

The intricate decorative line detail and soft modern edge of Anwick create a unique and unrivaled contemporary look. Offered in extended lengths, this sleek pull design helps create a continuous clean line on wide drawers for a balanced and streamlined look.



Shown in Satin Nickel





Knobs	Description	Overall Length	Foot Width x Length	Projection	Inner Box	Price Code
867	rectangle knob	1-3/8"	5/8" x 5/16"	1-1/16"	30	[E]
867L	square knob	1-1/8"	1-1/8" x 5/16"	1-1/16"	20	[E]

Pulls	Center-to-Center	Overall Length	Foot Width x Length	Projection	Inner Box	Price Code
867-3	3" CC	4-5/16"	5/8" x 5/16"	1-1/16"	10	[F]
867-96	96 mm (3-3/4") CC	5-1/8"	5/8" x 5/16"	1-1/16"	10	[G]
867-128	128 mm (5-1/16") CC	6-3/8"	5/8" x 5/16"	1-1/16"	10	[H]
867-160	160 mm (6-5/16") CC	7-5/8"	5/8" x 5/16"	1-1/16"	10	[J]
867-228	228 mm (9") CC	10-5/16"	5/8" x 5/16"	1-1/16"	10	[K]
867-320	320 mm (12-5/8") CC	13-15/16"	5/8" x 5/16"	1-1/16"	10	[K]

## Finishes



**BNBDL**  
Brushed Pewter



**DBAC**  
Brushed Oil  
Rubbed Bronze



**NI**  
Polished Nickel



**SN**  
Satin Nickel

# Audrey

*New collection*

Patent Pending



Knobs	Description	Overall Length	Foot Width x Length	Projection	Inner Box	Price Code
278	square knob	1-1/8"	1/2" x 1/2"	1-7/16"	10	[D]
278L	large square knob	1-3/8"	1/2" x 1/2"	1-7/16"	10	[D]

Pulls	Center-to-Center	Overall Length	Foot Width x Length	Projection	Inner Box	Price Code
278-96	96 mm (3-3/4") CC	4-1/4"	1/2" x 1/2"	1-1/2"	10	[E]
278-128	128 mm (5-1/16") CC	5-9/16"	1/2" x 1/2"	1-1/2"	10	[F]
278-160	160 mm (6-5/16") CC	6-13/16"	1/2" x 1/2"	1-1/2"	10	[G]
278-192	192 mm (7-9/16") CC	8-1/16"	1/2" x 1/2"	1-1/2"	10	[H]
278-224	224 mm (8-3/16") CC	9-3/8"	9/16" x 9/16"	1-9/16"	10	[H]
278-305	305 mm (12") CC	12-9/16"	9/16" x 9/16"	1-9/16"	10	[K]
278-12	12" CC appliance handle	12-5/8"	3/4" x 3/4"	2-1/4"	1	[K]
278-18	18" CC appliance handle	18-3/4"	3/4" x 3/4"	2-1/4"	1	[K]

# JEFFREY ALEXANDER®

by Hardware Resources



Shown in Brushed Pewter

## Poised

Poised and effortlessly charming, Audrey from Jeffrey Alexander adds understated elegance to any room. An impeccably tailored silhouette on both the cabinet knob and pull, this collection delivers a modern expression with lavish contours, sparkling with charisma and class.

### Finishes



**BG**  
Brushed  
Gold



**BNBDL**  
Brushed  
Pewter



**DBAC**  
Brushed Oil  
Rubbed Bronze



**MB**  
Matte Black



**PC**  
Polished  
Chrome



**SBZ**  
Satin Bronze



**SN**  
Satin Nickel



## Classic

With its soft, square foot and gentle curves, Belcastel 1 embodies a classic and dashing personality. This collection is a chameleon harmoniously melding its eleven different finishes with shaker, traditional, or slab style cabinets.



Shown in Satin Nickel

### Finishes



**ABM-D**  
Distressed  
Antique Brass



**BNBDL**  
Brushed  
Pewter



**DACM**  
Gun Metal



**DBAC**  
Brushed Oil  
Rubbed Bronze



**DMAC**  
Distressed Oil  
Rubbed Bronze



**MB**  
Matte Black



**NI**  
Polished  
Nickel



**PC**  
Polished  
Chrome



**SBZ**  
Satin Bronze



**SIM-D**  
Distressed  
Antique Silver



**SN**  
Satin Nickel

# Belcastel 1



Knobs	Description	Diameter	Foot Width x Length	Projection	Inner Box	Price Code
MO6303	round knob	1-3/8"	11/16" x 13/16"	1-1/16"	20	[D]

Pulls	Center-to-Center	Overall Length	Foot Width x Length	Projection	Inner Box	Price Code
MO6373	96 mm (3-3/4") CC	4-5/8"	3/4" x 7/8"	1-3/16"	15	[E]
MO6373-128	128 mm (5-1/16") CC	5-7/8"	3/4" x 7/8"	1-3/16"	20	[F]
MO6373-160	160 mm (6-5/16") CC	7-1/8"	3/4" x 7/8"	1-3/16"	10	[G]
MO6373-12	12" CC appliance handle	13-1/4"	1-1/8" x 1-1/4"	2-5/16"	5	[K]
MO6373-18	18" CC appliance handle	19-1/4"	1-1/8" x 1-1/4"	2-5/16"	5	[K]

# Bella

US Patent #  
D662,388; D661,972; D660,679

JEFFREY ALEXANDER®  
by Hardware Resources



Knobs	Description	Diameter	Foot Width x Length	Projection	Inner Box	Price Code
818	round knob	1-3/8"	5/8" x 5/8"	1-1/8"	20	[F]
818L	T-knob	2-1/4"	5/8" x 5/8"	1-3/8"	20	[G]

Pulls	Center-to-Center	Overall Length	Foot Width x Length	Projection	Inner Box	Price Code
818-96	96 mm (3-3/4") CC	4-3/8"	5/8" x 5/8"	1-3/8"	15	[H]
818-128	128 mm (5-1/16") CC	5-11/16"	5/8" x 5/8"	1-3/8"	15	[H]
818-160	160 mm (6-5/16") CC	6-15/16"	5/8" x 5/8"	1-3/8"	10	[J]
818-12	12" CC appliance handle	13-1/8"	1-1/8" x 1-1/8"	2"	5	[K]

## Finishes



**ABSB**  
Antique Brushed  
Satin Brass



**BNBDL**  
Brushed Pewter



**DBAC**  
Brushed Oil  
Rubbed Bronze



**NI**  
Polished Nickel



**SN**  
Satin Nickel



Knobs	Description	Overall Length	Foot Width x Length	Projection	Inner Box	Price Code
3990	oval knob	1-3/16"	9/16" x 9/16"	1-5/16"	25	[D]

Pulls	Center-to-Center	Overall Length	Foot Width x Length	Projection	Inner Box	Price Code
8236	96 mm (3-3/4") CC	5"	1-5/16" x 5"	1-3/16"	25	[E]

## Finishes



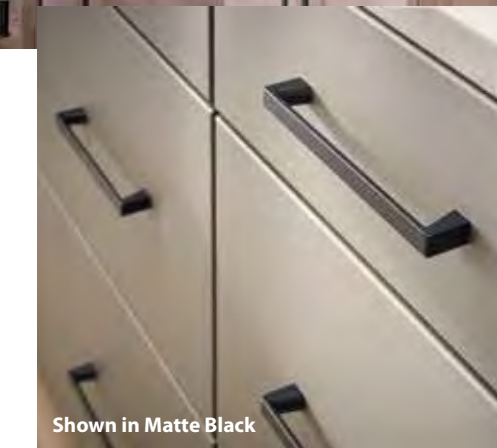

## Contemporary

Boswell combines gentle lines and a gracefully angled foot putting a modern twist on the traditional square bar pull. Adding a rounded undercurve for a touch of delicacy to the overall sleek profile, this pull collection is ideally suited to today's top trending soft contemporary styles.





Pulls	Center-to-Center	Overall Length	Foot Width x Length	Projection	Inner Box	Price Code
177-96	96 mm (3-3/4") CC	4-1/4"	1/2" x 5/8"	1-1/16"	15	[E]
177-128	128 mm (5-1/16") CC	5-9/16"	1/2" x 5/8"	1-1/16"	15	[F]
177-160	160 mm (6-5/16") CC	6-13/16"	1/2" x 5/8"	1-1/16"	10	[G]
177-192	192 mm (7-9/16") CC	8-1/16"	1/2" x 5/8"	1-1/16"	10	[G]
177-224	224 mm (8-13/16") CC	9-5/16"	1/2" x 5/8"	1-1/16"	10	[H]

## Finishes



**BNBDL**  
Brushed Pewter



**DBAC**  
Brushed Oil  
Rubbed Bronze



**MB**  
Matte Black



**PC**  
Polished Chrome



**SN**  
Satin Nickel

# Bremen 1



Knobs	Description	Diameter	Foot Width x Length	Projection	Inner Box	Price Code
117	round knob	1-1/4"	3/4" x 3/4"	1-1/16"	20	[D]

Pulls	Center-to-Center	Overall Length	Foot Width x Length	Projection	Inner Box	Price Code
527	96 mm (3-3/4") CC	4-5/8"	7/8" x 7/8"	1-3/16"	15	[F]
527-128	128 mm (5-1/16") CC	5-7/8"	13/16" x 13/16"	1-1/8"	10	[F]
527-160	160 mm (6-5/16") CC	7-1/8"	13/16" x 13/16"	1-1/8"	10	[H]
527-12	12" CC appliance handle	13-1/8"	1-1/8" x 1-1/8"	2-1/16"	5	[K]

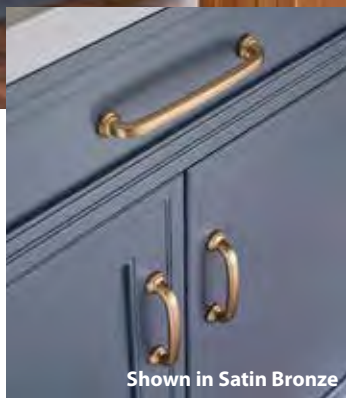

Shown in Satin Bronze

## Effortless

The stylish curves and simple stacked feet of Bremen 1 deliver effortless appeal and pizzazz to cabinets. Mirroring those appealing qualities in its button knob, this collection is equally at home in transitional or traditional settings.

### Finishes



**ABM-D**  
Distressed  
Antique Brass



**ABSB**  
Antique Brushed  
Satin Brass



**BNBDL**  
Brushed  
Pewter



**DACM**  
Gun Metal



**DBAC**  
Brushed Oil  
Rubbed Bronze



**DMAC**  
Distressed Oil  
Rubbed Bronze



**NI**  
Polished Nickel



**PC**  
Polished  
Chrome



**SBZ**  
Satin Bronze



**SIM**  
Distressed  
Antique Silver



**SN**  
Satin Nickel



Shown in Gun Metal

## Unfailing

The unfailing style of Jeffrey Alexander's Bremen 2 is highlighted by slight curves and a sturdy presence. The stacked barrel design is echoed across three standard pull lengths, an appliance handle, and two coordinating knobs. Bremen 2 feels at home in either a traditional or American Country design.

### *Design Idea*

Achieve a confidently understated look by pairing dark cabinet finishes with dark hardware.

# Bremen 2



Knobs	Description	Diameter	Foot Width x Length	Projection	Inner Box	Price Code
127	barrel knob	1-3/16"	13/16" x 13/16"	1-1/8"	20	[D]
137	stacked knob	1-1/4"	3/4" x 3/4"	1-1/8"	30	[D]

Pulls	Center-to-Center	Overall Length	Foot Width x Length	Projection	Inner Box	Price Code
537	96 mm (3-3/4") CC	4-3/16"	3/8" x 3/8"	1-1/4"	20	[E]
537-128	128 mm (5-1/16") CC	5-7/16"	3/8" x 3/8"	1-1/4"	10	[F]
537-160	160 mm (6-5/16") CC	6-11/16"	3/8" x 3/8"	1-1/4"	10	[F]
537-12	12" CC appliance handle	12-11/16"	11/16" x 11/16"	1-5/8"	5	[K]

## Finishes



**ABSB**  
Antique Brushed  
Satin Brass

**DACM**  
Gun Metal

**DBAC**  
Brushed Oil  
Rubbed Bronze

**DMAC**  
Distressed Oil  
Rubbed Bronze

**NI**  
Polished Nickel

**SN**  
Satin Nickel

# Cairo



Knobs	Description	Overall Length	Foot Width x Length	Projection	Inner Box	Price Code
595	pyramid knob	1-1/4"	5/8" x 5/8"	7/8"	20	[D]

Pulls	Center-to-Center	Overall Length	Foot Width x Length	Projection	Inner Box	Price Code
595-96	96 mm (3-3/4") CC	4-13/16"	1" x 11/16"	1-1/8"	20	[E]
595-128	128 mm (5-1/16") CC	6-1/16"	1" x 11/16"	1-1/8"	15	[E]





## Reminiscent

Reminiscent of the pyramids in Egypt, Cairo's dramatic faceted design meets elegant curves to create a look that echoes architectural history. The angled profile of this knob and pull combination catches the light in just the right way to add grandeur to cabinets.

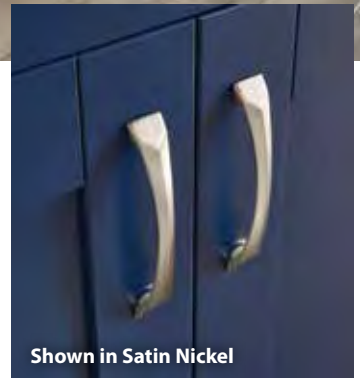

Shown in Satin Nickel

### Finishes



**BNBDL**  
Brushed Pewter

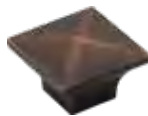

**DBAC**  
Brushed Oil  
Rubbed Bronze



**PC**  
Polished Chrome



**SN**  
Satin Nickel



## Sophisticated

Sophisticated and streamlined, Callie will enhance any transitional or contemporary space. Pairing clean lines and subtle curves, this pull collection not only looks great but also feels great in your hand thanks to its rounded grip.



Shown in Brushed Pewter



# Callie

US Patent #  
D790,315



Pulls	Center-to-Center	Overall Length	Foot Width x Length	Projection	Inner Box	Price Code
839-3	3" CC	4-3/16"	7/16" x 13/16"	1-1/4"	20	[E]
839-96	96 mm (3-3/4") CC	4-15/16"	7/16" x 13/16"	1-1/4"	15	[F]
839-128	128 mm (5-1/16") CC	6-1/4"	7/16" x 13/16"	1-1/4"	15	[G]
839-160	160 mm (6-5/16") CC	7-1/2"	7/16" x 13/16"	1-1/4"	10	[H]

## Finishes



# Carmen

US Patent #

D787,297; D787,296



Knobs	Description	Overall Length/ Diameter	Foot Width x Length	Projection	Inner Box	Price Code
775	round knob	1-1/8"	3/8" x 3/8"	1-7/16"	25	[F]
775L	T-knob	2"	3/8" x 3/8"	1-3/8"	25	[F]

Pulls	Center-to-Center	Overall Length	Foot Width x Length	Projection	Inner Box	Price Code
775-96	96 mm (3-3/4") CC	4-3/4"	3/8" x 3/8"	1-3/8"	10	[H]
775-128	128 mm (5-1/16") CC	6"	3/8" x 3/8"	1-3/8"	10	[J]
775-160	160 mm (6-5/16") CC	7-1/4"	3/8" x 3/8"	1-3/8"	10	[J]

## Finishes



**BG**  
Brushed  
Gold



**MB**  
Matte  
Black



**NI**  
Polished  
Nickel



**PC**  
Polished  
Chrome



**SBZ**  
Satin  
Bronze



**SN**  
Satin  
Nickel



## Brilliant

Bold, beautiful, and brilliant, Carmen is the perfect union of classic and contemporary. With its crystal-clear acrylic bar and industrial yet elegant stepped detail, this lustrous fusion evokes everlasting style with a modern-day twist. Carmen shares the same profile as the Hayworth collection (see page 38-39).

### *Design Idea*

Have fun and mix Carmen's beautiful acrylic with the solid options in Hayworth to instantly brighten your kitchen, bath, or closet.



**Shown in Satin Bronze**

# Cordova

JEFFREY ALEXANDER®  
by Hardware Resources



Knobs	Description	Diameter	Foot		Inner Box	Price Code
			Width x Length	Projection		
0251	flat top knob	1-3/8"	1-1/16" x 1-1/16"	1-1/16"	25	[C]
Z110	flared base knob	1-3/16"	3/4" x 3/4"	1-1/16"	30	[B]
Z111	button knob	1-1/4"	11/16" x 11/16"	1"	30	[C]

Pulls	Center-to-Center	Overall Length	Foot		Inner Box	Price Code
			Width x Length	Projection		
Z281	3" CC	3-3/8"	13/16" x 3/8"	1-1/4"	20	[D]
Z280	96 mm (3-3/4") CC	4-3/16"	13/16" x 3/8"	1-1/4"	20	[E]
Z281-128	128 mm (5-1/16") CC	5-7/16"	13/16" x 3/8"	1-5/16"	10	[F]
Z281-160	160 mm (6-5/16") CC	6-11/16"	13/16" x 3/8"	1-1/4"	10	[H]
Z281-12	12" CC appliance handle	12-3/4"	1-9/16" x 3/4"	2-1/16"	5	[K]
Z281-18	18" CC appliance handle	18-3/4"	1-9/16" x 3/4"	2-1/16"	5	[K]

## Finishes



**ABSB**  
Antique Brushed  
Satin Brass



**BNSBL**  
Brushed Pewter  
(0251 only)



**BNDL**  
Distressed Pewter



**DBAC**  
Brushed Oil  
Rubbed Bronze



**SN**  
Satin Nickel



Knobs	Description	Overall Length	Foot Width x Length	Projection	Inner Box	Price Code
519	T-knob	1-9/16"	1/2" x 1/2"	1-1/4"	30	[F]

Pulls	Center-to-Center	Overall Length	Foot Width x Length	Projection	Inner Box	Price Code
519-96	96 mm (3-3/4") CC	4-1/4"	3/4" x 1/2"	1-3/16"	10	[H]
519-128	128 mm (5-1/16") CC	5-9/16"	3/4" x 1/2"	1-3/16"	10	[K]
519-160	160 mm (6-5/16") CC	6-13/16"	3/4" x 1/2"	1-3/16"	10	[K]
519-12	12" CC appliance handle	12-1/2"	3/4" x 1/2"	1-1/2"	5	[K]
519-18	18" CC appliance handle	18-1/2"	3/4" x 1/2"	1-1/2"	5	[K]

## Finishes



US Patent #

D680,409; D680,414; D680,408



Knobs	Description	Overall Length	Foot Width x Length	Projection	Inner Box	Price Code
585	small square knob	1"	3/4" x 3/4"	1"	20	[F]
585L	large square knob	1-1/4"	3/4" x 3/4"	1"	20	[G]

Pulls	Center-to-Center	Overall Length	Foot Width x Length	Projection	Inner Box	Price Code
585-96	96 mm (3-3/4") CC	4-1/2"	11/16" x 5/8"	1-1/8"	10	[H]
585-128	128 mm (5-1/16") CC	5-13/16"	11/16" x 5/8"	1-1/8"	10	[J]
585-160	160 mm (6-5/16") CC	7-1/16"	11/16" x 5/8"	1-1/8"	10	[K]
585-12	12" CC appliance handle	13-1/4"	3/4" x 7/8"	1-1/2"	5	[K]

## Finishes



**BNBDL**  
Brushed Pewter



**DACM**  
Gun Metal



**DBAC**  
Brushed Oil  
Rubbed Bronze



**DP**  
Distressed Pewter



**SN**  
Satin Nickel



Knobs	Description	Diameter	Foot Width x Length	Projection	Inner Box	Price Code
3980	round knob	1-1/4"	1" x 1"	1"	20	[F]

Pulls	Center-to-Center	Overall Length	Foot Width x Length	Projection	Inner Box	Price Code
Z290-3	3" CC	3-3/8"	3/8" x 3/8"	1-5/16"	25	[D]
Z290-96	96 mm (3-3/4") CC	4-1/4"	1/2" x 1/2"	1-5/16"	20	[D]
Z290-128	128 mm (5-1/16") CC	5-1/2"	1/2" x 1/2"	1-7/16"	15	[G]
Z290-160	160 mm (6-5/16") CC	6-3/4"	1/2" x 1/2"	1-9/16"	10	[H]
Z290-12	12" CC appliance handle	13"	1" x 1"	2-1/8"	5	[K]

### Finishes



ABSB  
Antique  
Brushed  
Satin Bronze

BNBDL  
Brushed  
Pewter

DACM  
Gun  
Metal

DBAC  
Brushed Oil  
Rubbed  
Bronze

MB  
Matte  
Black

ORB  
Dark  
Bronze

PC  
Polished  
Chrome

SN  
Satin  
Nickel

# Dominique



Knobs	Description	Overall Length	Foot		Projection	Inner Box	Price Code
			Width x Length				
845	square knob	1-1/8"	7/16" x 7/16"		1-3/16"	20	[D]
845T	T-knob	2"	3/8" x 3/8"		1-3/16"	20	[D]
845TL	long T-knob	2-1/4"	3/8" x 3/8"		1-3/16"	20	[E]

Pulls	Center-to-Center	Overall Length	Foot		Projection	Inner Box	Price Code
			Width x Length				
845-96	96 mm (3-3/4") CC	5-3/4"	5/16" x 5/16"		1-3/16"	10	[F]
845-128	128 mm (5-1/16") CC	7-1/16"	5/16" x 5/16"		1-3/16"	10	[F]
845-160	160 mm (6-5/16") CC	8-5/16"	5/16" x 5/16"		1-3/16"	10	[G]
845-192	192 mm (7-9/16") CC	9-9/16"	5/16" x 5/16"		1-3/16"	10	[H]
845-305	305 mm (12") CC	14"	5/16" x 5/16"		1-3/16"	10	[K]
845-12	12" CC appliance handle	15"	1/2" x 1/2"		1-7/8"	5	[K]
845-18	18" CC appliance handle	21"	1/2" x 1/2"		1-7/8"	5	[K]





## Daring

Dominique fuses daring lines with a delicate contour, resulting in a perfect balance of grace and power. With an abundance of pull lengths and knob shapes to choose from, this collection is a winning choice for transitional and contemporary designs.



Shown in Matte Black

### Finishes



**BG**  
Brushed  
Gold



**BNBDL**  
Brushed  
Pewter



**DBAC**  
Brushed Oil  
Rubbed  
Bronze



**MB**  
Matte  
Black



**PC**  
Polished  
Chrome



**SBZ**  
Satin  
Bronze



**SN**  
Satin  
Nickel



## Boundless

Elara's chic, European style brings a fresh, upscale perspective to any room. Mix bold round knobs with elegantly curved pinch pulls for boundless design possibilities.

### Finishes



**BNBDL**  
Brushed Pewter



**DBAC**  
Brushed Oil  
Rubbed Bronze



**MB**  
Matte Black



**PC**  
Polished  
Chrome



**SBZ**  
Satin Bronze



**SN**  
Satin Nickel



Knobs	Description	Diameter	Foot Width x Length	Projection	Inner Box	Price Code
484	round knob	1-1/4"	7/8" x 7/8"	15/16"	20	[D]
Pulls	Center-to-Center	Overall Length	Foot Width x Length	Projection	Inner Box	Price Code
484-32	32 mm (1-1/4") CC	2-1/8"	9/16" x 2-1/8"	15/16"	15	[D]
484-396	3" CC & 96 mm (3-3/4") CC	4-5/8"	9/16" x 4-5/8"	15/16"	20	[F]
484-128160	128 mm (5-1/16") CC & 160 mm (6-5/16") CC	7-1/8"	9/16" x 7-1/8"	15/16"	10	[H]
484-192224	192 mm (7-9/16") CC & 224 mm (8-13/16") CC	9-5/8"	9/16" x 9-5/8"	15/16"	15	[J]
484-305	305 mm (12") CC	12-13/16"	9/16" x 12-13/16"	15/16"	5	[K]

## Design Idea

Create a snag-free space (like in closets and laundry rooms) by choosing pulls that have feet that touch the face of the cabinet instead of having an overhang. Your clothes will thank you.

### 3 pull sizes offer 2 center-to-center options

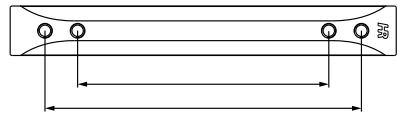

# Ella

US Patent #  
D737,112; D728,343



Knobs	Description	Overall Length	Foot Width x Length	Projection	Inner Box	Price Code
165	geometric knob	1-1/4"	9/16" x 13/16"	1-1/8"	20	[E]

Pulls	Center-to-Center	Overall Length	Foot Width x Length	Projection	Inner Box	Price Code
165-96	96 mm (3-3/4") CC	4-1/2"	15/16" x 3/4"	1-3/16"	10	[G]
165-128	128 mm (5-1/16") CC	5-13/16"	15/16" x 3/4"	1-3/16"	10	[H]
165-160	160 mm (6-5/16") CC	7-1/16"	15/16" x 3/4"	1-3/16"	10	[J]
165-12	12" CC appliance handle	13"	1-1/4" x 1"	1-5/8"	5	[K]

## Finishes



**BNBDL**  
Brushed Pewter



**DBAC**  
Brushed Oil  
Rubbed Bronze



**NI**  
Polished Nickel



**PC**  
Polished Chrome



**SN**  
Satin Nickel



## Dazzling

With its soft square design and wider chamfer with strap detail, Ella's dazzling personality adds brilliance to any kitchen. Accented with a matching faceted knob, resembling an emerald-cut jewel, this collection is the epitome of "jewelry for the kitchen."

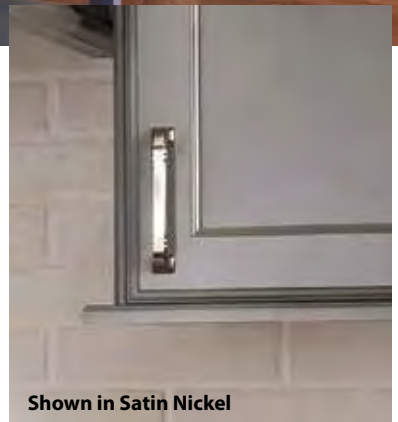

Shown in Satin Nickel



## Glamorous

Recalling the glamorous era of Old Hollywood, Harlow's glass knobs add excitement and radiance to any kitchen, bath, or closet. This knob collection offers five alluring shapes that are the perfect accent to traditional or transitional design schemes.



**G210L shown in Polished Chrome base**



Knobs	Description	Overall Length/ Diameter	Foot Width x Length	Projection	Inner Box	Price Code
G110	small oval	1-1/4"	7/8" x 7/8"	1-3/8"	10	[G]
G110L	large oval	1-5/8"	7/8" x 7/8"	1-11/16"	10	[J]
G120	small button	1-7/16"	7/8" x 7/8"	1-9/16"	10	[G]
G120L	large button	1-3/4"	7/8" x 7/8"	1-5/8"	10	[J]
G130	small sphere	1-1/16"	11/16" x 11/16"	1-7/16"	10	[G]
G130L	large sphere	1-3/8"	7/8" x 7/8"	1-5/8"	10	[H]
G140	small square	1"	11/16" x 11/16"	1-3/16"	10	[G]
G140L	large square	1-3/8"	7/8" x 7/8"	1-5/16"	10	[J]
G150	small faceted	1"	11/16" x 11/16"	1-1/4"	10	[G]
G150L	large faceted	1-1/4"	7/8" x 7/8"	1-1/2"	10	[H]

The Harlow knobs have a post that needs an easy extra step to achieve a flush mount. Once you have drilled your hole with a 3/16" bit, use a 1/4" bit to expand the hole on the face of the door/drawer front to seat the post of the Harlow knob.

## Base Finishes



**BNBDL**

Brushed Pewter

**DBAC**

Brushed Oil  
Rubbed Bronze

**PC**

Polished Chrome

**SN**

Satin Nickel

# Hayworth

US Patent #  
D787,297; D787,296



Knobs	Description	Overall Length/ Diameter	Foot Width x Length	Projection	Inner Box	Price Code
885	round knob	1-1/8"	3/8" x 3/8"	1-7/16"	25	[E]
885L	T-knob	2"	3/8" x 3/8"	1-3/8"	25	[E]

Pulls	Center-to-Center	Overall Length	Foot Width x Length	Projection	Inner Box	Price Code
885-96	96 mm (3-3/4") CC	4-3/4"	3/8" x 3/8"	1-3/8"	10	[G]
885-128	128 mm (5-1/16") CC	6"	3/8" x 3/8"	1-3/8"	10	[H]
885-160	160 mm (6-5/16") CC	7-1/4"	3/8" x 3/8"	1-3/8"	10	[H]
885-192	192 mm (7-9/16") CC	8-1/2"	3/8" x 3/8"	1-3/8"	10	[J]
885-224	224 mm (8-13/16") CC	9-3/4"	3/8" x 3/8"	1-3/8"	10	[J]
885-305	305 mm (12") CC pull	12-15/16"	3/8" x 3/8"	1-3/8"	10	[K]





## Industrial

The pairing of industrial and elegant is one that is not often combined, but that is what Hayworth precisely personifies! The simple yet trendy pull and knob collection offers a clean design while providing a substantial profile through its stepped detail. Hayworth shares the same profile with the Carmen Acrylic collection (see page 24-25).

### *Design Idea*

Shake things up and strategically mix in acrylic knobs and pulls from Carmen with Hayworth to make a fun statement.



**Shown in Satin Bronze**

### Finishes



**BG**

Brushed Gold



**MB**

Matte Black



**NI**

Polished Nickel



**PC**

Polished Chrome



**SBZ**

Satin Bronze



**SN**

Satin Nickel



Knobs	Description	Overall Length	Foot Width x Length	Projection	Inner Box	Price Code
650	oval knob	1-7/8"	5/8" x 5/8"	1"	25	[D]

Pulls	Center-to-Center	Overall Length	Foot Width x Length	Projection	Inner Box	Price Code
650-96	96 mm (3-3/4") CC	4-3/8"	7/8" x 5/8"	1-1/4"	30	[E]
650-128	128 mm (5-1/16") CC	5-1/16"	7/8" x 5/8"	1-1/4"	25	[F]
650-160	160 mm (6-5/16") CC	6-15/16"	7/8" x 5/8"	1-3/8"	10	[G]
650-12	12" CC appliance handle	13"	1-3/8" x 1"	1-9/16"	5	[K]

### Finishes



**BNBDL**  
Brushed Pewter



**DBAC**  
Brushed Oil Rubbed Bronze



**PC**  
Polished Chrome



**SN**  
Satin Nickel



Knobs	Description	Overall Length	Foot Width x Length	Projection	Inner Box	Price Code
188	small knob	7/8"	11/16" x 11/16"	1-3/8"	20	[E]
188L	large knob	1"	13/16" x 13/16"	1-7/16"	15	[F]

Pulls	Center-to-Center	Overall Length	Foot Width x Length	Projection	Inner Box	Price Code
188-96	96 mm (3-3/4") CC	4-3/8"	5/8" x 5/8"	1-7/16"	15	[G]
188-128	128 mm (5-1/16") CC	5-11/16"	5/8" x 5/8"	1-7/16"	15	[H]
188-160	160 mm (6-5/16") CC	6-15/16"	5/8" x 5/8"	1-7/16"	10	[J]

### Finishes



**BNBDL**  
Brushed Pewter



**DBAC**  
Brushed Oil  
Rubbed Bronze



**PC**  
Polished Chrome



**SN**  
Satin Nickel

# Key Grande

*New knob + finishes*



Knob	Description	Overall Length	Foot Width x Length	Projection	Inner Box	Price Code
51 <b>NEW</b>	T-Knob	2"	7/16" x 3/8"	1-5/16"	20	[H]
Pulls	Center-to-Center	Overall Length	Foot Width x Length	Projection	Inner Box	Price Code
596	96 mm (3-3/4") CC	5-3/8"	7/16" x 3/8"	1-5/16"	20	[H]
5128	128 mm (5-1/16") CC	6-5/8"	7/16" x 3/8"	1-5/16"	20	[H]
5192	192 mm (7-9/16") CC	9-1/8"	7/16" x 3/8"	1-5/16"	10	[J]
5224	224 mm (8-13/16") CC	10-3/8"	7/16" x 3/8"	1-5/16"	10	[J]
5319	319 mm (12-9/16") CC	14-1/8"	7/16" x 3/8"	1-5/16"	10	[K]
5480*	480 mm (18-7/8") CC	20-1/2"	7/16" x 3/8"	1-5/16"	10	[K]
5673*	673 mm (26-1/2") CC	28-1/16"	7/16" x 3/8"	1-5/16"	10	[K]
5900*	900 mm (35-7/16") CC	37"	7/16" x 3/8"	1-5/16"	5	[K]

\*Available in Satin Nickel only



Shown in Brushed Gold

## Refined

The simple, clean lines of this beveled bar pull blend with any cabinet style in kitchens, baths, and even laundry rooms. Key Grande's added strap detail offers a refined upgrade to the traditional bar pull.

### Finishes



**BG**  
Brushed Gold  
(up to 319 mm CC)



**MB NEW**  
Matte Black  
(up to 319 mm CC)



**SN**  
Satin Nickel  
(all lengths)



**MBBG NEW**  
Matte Black  
with Brushed Gold  
(up to 319 mm CC)



**MBSN NEW**  
Matte Black  
with Satin Nickel  
(up to 319 mm CC)



Shown in Matte Black

## Enduring

The enduring bar pull design is comfortable, distinguished, and always a crowd-pleaser. Expanded to offer top-trending finishes and extended lengths for oversized drawers, the presence of Key West and Key Largo will stand the test of time.

### Finishes



**BG**

Brushed Gold  
(up to 320 mm CC)



**MB**

Matte Black  
(up to 320 mm CC)



**ORB**

Dark Bronze  
(up to 178 mm CC)



**SBZ**

Satin Bronze  
(up to 320 mm CC)



**SN**

Satin Nickel  
(all lengths)

# Key West & Key Largo



Knobs	Description	Overall Length	Foot Width & Length	Projection	Inner Box	Price Code
48	T-knob	1-7/8"	1/2" x 1/2"	1-7/16"	30	[D]
Pulls	Center-to-Center	Overall Length	Foot Width & Length	Projection	Inner Box	Price Code
146	96 mm (3-3/4") CC	5-3/4"	1/2" x 1/2"	1-7/16"	10	[F]
152	96 mm (3-3/4") CC	6"	1/2" x 1/2"	1-7/16"	10	[F]
178	128 mm (5-1/16") CC	7"	1/2" x 1/2"	1-7/16"	10	[G]
242*	192 mm (7-9/16") CC	9-1/2"	1/2" x 1/2"	1-7/16"	10	[G]
274*	224 mm (8-13/16") CC	10-13/16"	1/2" x 1/2"	1-7/16"	10	[H]
370*	320mm (12-5/8") CC	14-9/16"	1/2" x 1/2"	1-7/16"	10	[H]
530†	480 mm (18-7/8") CC	20-7/8"	1/2" x 1/2"	1-7/16"	10	[J]
722†	673 mm (26-1/2") CC	28-7/16"	1/2" x 1/2"	1-7/16"	10	[K]
950†	900 mm (35-7/16") CC	37-3/8"	1/2" x 1/2"	1-7/16"	10	[K]

\*Available in Brushed Gold, Matte Black, Satin Bronze, and Satin Nickel finishes

†Only available in Satin Nickel finish

## Design Idea

For a streamlined and more modern look, choose longer pulls to complement your wider drawers.

# Lafayette

JEFFREY ALEXANDER®  
by Hardware Resources

US Patent #  
D605,924; D602,334; D637,059



Knobs	Description	Diameter	Foot Width & Length	Projection	Inner Box	Price Code
218	fleur-de-lis knob	1-3/8"	7/8" x 7/8"	1-1/4"	30	[F]
317	circles knob	1-3/8"	11/16" x 11/16"	1-1/8"	20	[F]
417	Baroque pattern knob	1-3/8"	3/4" x 3/4"	1-1/8"	30	[F]

Pulls	Center-to-Center	Overall Length	Foot Width & Length	Projection	Inner Box	Price Code
317-96	96 mm (3-3/4") CC	4-3/8"	9/16" x 9/16"	1-1/4"	20	[G]
317-128	128 mm (5-1/16") CC	5-5/8"	9/16" x 9/16"	1-3/8"	20	[H]
317-160	160 mm (6-5/16") CC	6-7/8"	9/16" x 9/16"	1-7/16"	15	[H]
317-12	12" CC appliance handle	12-15/16"	7/8" x 7/8"	2-3/16"	5	[K]

## Finishes



**ABSB**  
Antique Brushed  
Satin Brass



**BNBDL**  
Brushed Pewter



**DBAC**  
Brushed Oil  
Rubbed Bronze



**SN**  
Satin Nickel





Knobs	Description	Overall Length	Foot Width x Length	Projection	Inner Box	Price Code
3991	oval knob	1-9/16"	11/16" x 11/16"	1-5/8"	25	[E]

Pulls	Center-to-Center	Overall Length	Foot Width x Length	Projection	Inner Box	Price Code
8233	3" CC	4-15/16"	4-15/16" x 1-7/16"	1"	25	[D]

**Finishes**



# Leyton



Pulls	Center-to-Center	Overall Length	Foot Width x Length	Projection	Inner Box	Price Code
286-96	96 mm (3-3/4") CC	5-1/8"	5/16" x 7/8"	1-3/16"	10	[F]
286-128	128 mm (5-1/16") CC	6-3/8"	5/16" x 7/8"	1-3/16"	10	[G]
286-160	160 mm (6-5/16") CC	7-11/16"	5/16" x 7/8"	1-3/16"	10	[H]
286-192	192 mm (7-9/16") CC	8-15/16"	5/16" x 7/8"	1-3/16"	10	[H]
286-224	224 mm (8-13/16") CC	10-3/16"	5/16" x 7/8"	1-3/16"	10	[J]

## Finishes



**BNBDL**  
Brushed Pewter



**DBAC**  
Brushed Oil  
Rubbed Bronze



**MB**  
Matte Black



**NI**  
Polished Nickel



**PC**  
Polished Chrome



**SBZ**  
Satin Bronze



**SN**  
Satin Nickel



## Distinctive

Leyton's relaxed yet distinctive asymmetrical silhouette is fun and flexible. An ideal complement to mid-century modern design with its clean lines and gentle curves, this pull collection also harmonizes with contemporary design's straight lines and geometric shapes.

### *Design Idea*

For a bold, modern feel, use gold-tone hardware on black cabinets.



Shown in Satin Bronze



## Regal

The regal presence of Marie adds subtle grandeur to your cabinets with its elegant swooping lines and jewelry-like cuff detail. Adapted from a Jeffrey Alexander classic, this pull features a soft arch that discreetly adds extra hand clearance without being imposing. Marie brings instant sophistication to any kitchen, bath, or closet.





Knobs	Description	Diameter	Foot Width x Length	Projection	Inner Box	Price Code
445	round knob	1-1/4"	11/16" x 11/16"	1-1/8"	10	[D]

Pulls	Center-to-Center	Overall Length	Foot Width x Length	Projection	Inner Box	Price Code
445-96	96 mm (3-3/4") CC	4-3/8"	5/8" x 5/8"	1-5/16"	10	[E]
445-128	128 mm (5-1/16") CC	5-5/8"	5/8" x 5/8"	1-1/2"	10	[F]
445-160	160 mm (6-5/16") CC	6-7/8"	5/8" x 5/8"	1-1/2"	10	[F]
445-192	192 mm (7-9/16") CC	8-3/16"	5/8" x 5/8"	1-1/2"	10	[G]
445-224	224 mm (8-13/16") CC	9-7/16"	5/8" x 5/8"	1-1/2"	10	[H]
445-305	305 mm (12") CC	12-11/16"	11/16" x 11/16"	1-1/2"	10	[K]
445-12	12" CC appliance handle	13"	1" x 1"	2-1/8"	1	[K]
445-18	18" CC appliance handle	19"	1" x 1"	2-1/8"	1	[K]

## Finishes



**BNBDL** Brushed Pewter    **DBAC** Brushed Oil Rubbed Bronze    **MB** Matte Black    **PC** Polished Chrome    **SBZ** Satin Bronze    **SN** Satin Nickel

# Marlo

US Patent #  
D786,648; D790,316



Knobs	Description	Overall Length	Foot Width x Length	Projection	Inner Box	Price Code
972S	small square knob	7/8"	7/16" x 7/16"	1"	30	[D]
972	medium square knob	1-1/8"	1/2" x 1/2"	1"	30	[E]
972L	large square knob	1-1/4"	9/16" x 9/16"	1"	20	[F]

Pulls	Center-to-Center	Overall Length	Foot Width x Length	Projection	Inner Box	Price Code
972-96	96 mm (3-3/4") CC	4-1/2"	1" x 3/4"	1-1/16"	10	[G]
972-128	128 mm (5-1/16") CC	5-13/16"	1" x 3/4"	1-1/16"	10	[H]
972-160	160 mm (6-5/16") CC	7-1/16"	1" x 3/4"	1-1/16"	10	[J]
972-224	224 mm (8-13/16") CC	9-3/4"	1" x 3/4"	1-1/16"	15	[J]
972-305	305 mm (12") CC	12-3/4"	1" x 3/4"	1-1/16"	10	[K]
972-12	12" CC appliance handle	13"	1-3/8" x 1"	1-1/2"	5	[K]

## Finishes



**BNBDL**  
Brushed Pewter



**DBAC**  
Brushed Oil  
Rubbed Bronze



**NI**  
Polished Nickel



**PC**  
Polished Chrome



**SN**  
Satin Nickel

# JEFFREY ALEXANDER®

by Hardware Resources



Shown in Satin Nickel

## Adaptable

Marlo blends a clean, square shape with a soft, chamfered edge, adaptable to any design scheme in any room. Confidently pair this soft, masculine pull with its coordinating knob. The multitude of size options in both knobs and pulls means this modern collection can accommodate almost any project.



Shown in Brushed Pewter



Shown in Satin Bronze

## Comfortable

Merrick's simple strap design is anything but with its subtle curves, broad profile, and clean square feet. A comfortable choice for various cabinet styles, this pull family's versatility makes it a popular choice.

### *Design Idea*

If you use two cabinet finishes, go with two distinctive cabinet knob or pull finishes of the same style to complement each cabinet color.





Pulls	Center-to-Center	Overall Length	Foot Width x Length	Projection	Inner Box	Price Code
549-96	96 mm (3-3/4") CC	4-3/16"	9/16" x 5/8"	1-1/16"	25	[E]
549-128	128 mm (5-1/16") CC	5-1/2"	9/16" x 5/8"	1-1/16"	15	[E]
549-160	160 mm (6-5/16") CC	6-3/4"	9/16" x 5/8"	1-1/16"	15	[F]
549-192	192 mm (7-9/16") CC	8"	9/16" x 5/8"	1-1/16"	20	[F]
549-320	320 mm (12-5/8") CC	13-1/16"	9/16" x 5/8"	1-1/16"	10	[K]

## Finishes

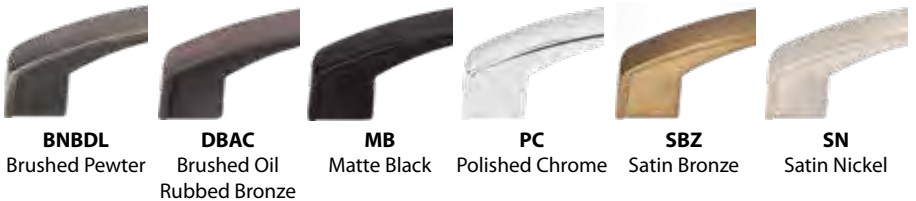

**BNBDL** Brushed Pewter   
 **DBAC** Brushed Oil Rubbed Bronze   
 **MB** Matte Black   
 **PC** Polished Chrome   
 **SBZ** Satin Bronze   
 **SN** Satin Nickel

# Milan 1



Knobs	Description	Overall Length	Foot Width x Length	Projection	Inner Box	Price Code
1091	square knob	1-1/4"	13/16" x 13/16"	1"	20	[E]

Pulls	Center-to-Center	Overall Length	Foot Width x Length	Projection	Inner Box	Price Code
1092	96 mm (3-3/4") CC	4-1/4"	1/2" x 1/2"	1-1/16"	20	[F]
1092-128	128 mm (5-1/16") CC	5-9/16"	1/2" x 1/2"	1-1/16"	25	[G]
1092-160	160 mm (6-5/16") CC	6-13/16"	1/2" x 1/2"	1-1/16"	20	[H]
1092-12	12" CC appliance handle	12-3/4"	13/16" x 13/16"	1-3/8"	5	[K]

## Finishes





## Charismatic

Charismatic and fashionable, the soft square design of Milan 1 has matured from a daring new shape to a timeless classic. The simple stepped square accents and the availability of an appliance pull make this collection a go-to for a variety of cabinet styles.



Shown in Gun Metal



Shown in Matte Black

## Adventurous

Be adventurous with the bold but somehow familiar strap pull of Mirada. Its broad vaulting strap mingled with a controlled rectangular foot and matching knob will doubtlessly make a statement.



<b>Knobs</b>	<b>Description</b>	<b>Overall Length</b>	<b>Foot Width x Length</b>	<b>Projection</b>	<b>Inner Box</b>	<b>Price Code</b>
81021	16 mm (5/8") CC knob	1-9/16"	1/4" x 7/8"	3/4"	30	[D]

<b>Pulls</b>	<b>Center-to-Center</b>	<b>Overall Length</b>	<b>Foot Width x Length</b>	<b>Projection</b>	<b>Inner Box</b>	<b>Price Code</b>
80152-96	96 mm (3-3/4") CC	5-9/16"	15/16" x 1-1/8"	1"	20	[G]
80152-128	128 mm (5-1/16") CC	6-13/16"	15/16" x 1-1/8"	1"	20	[H]
80152-160	160 mm (6-5/16") CC	8-1/16"	15/16" x 1-15/16"	1-1/8"	15	[H]

## Finishes

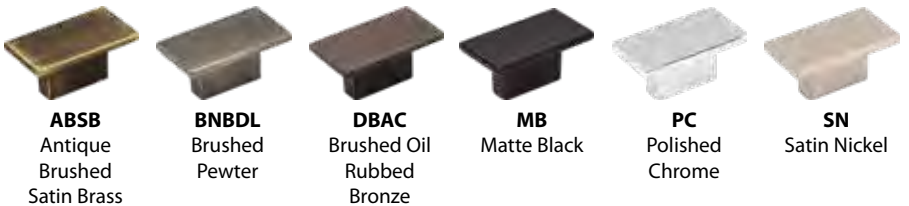

**ABSB**

Antique  
Brushed  
Satin Brass

**BNBDL**

Brushed  
Pewter

**DBAC**

Brushed Oil  
Rubbed  
Bronze

**MB**

Matte Black

**PC**

Polished  
Chrome

**SN**

Satin Nickel

# Philip



Knobs	Description	Overall Length	Foot Width x Length	Projection	Inner Box	Price Code
767	rectangle knob	1-1/4"	1/2" x 3/4"	1-1/16"	25	[D]

Pulls	Center-to-Center	Overall Length	Foot Width x Length	Projection	Inner Box	Price Code
767-96	96 mm (3-3/4") CC	5-1/16"	11/16" x 7/8"	1-1/16"	15	[E]
767-128	128 mm (5-1/16") CC	6-5/16"	11/16" x 7/8"	1-1/8"	10	[F]
767-160	160 mm (6-5/16") CC	7-9/16"	11/16" x 7/8"	1-1/8"	10	[G]

## Finishes



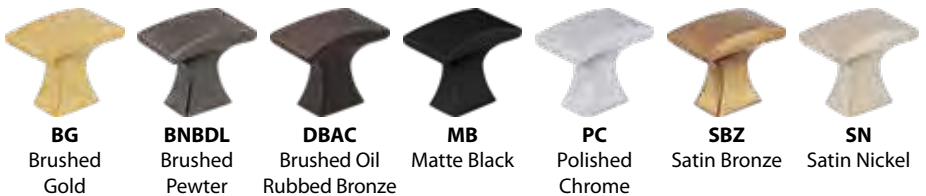

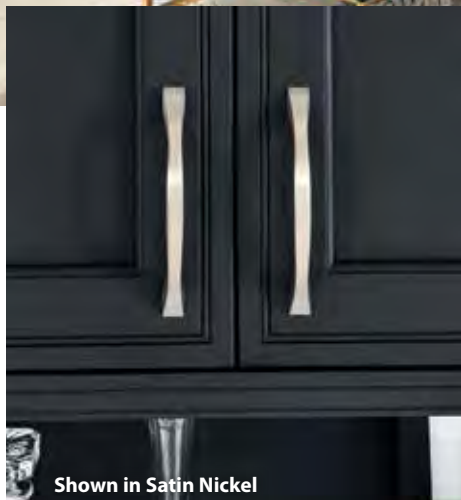
Shown in Satin Nickel

## Playful

The playful flare and soft lines of Philip's knob and pull create excitement and a bit of romance. The design options of this lively collection are matchless, making it a winning choice for any kitchen, bath, or closet.



## Remarkable

Rae tells a controlled yet remarkable tale through its crescentic shape. This pull has elongated lines with a softly rounded grip for a delightful embrace. Pair this impressive pull with one of three round knob sizes with similar concave detail to achieve a perfect, soft contemporary look.



Shown in Satin Nickel





Knobs	Description	Diameter	Foot Width x Length	Projection	Inner Box	Price Code
667S	small round knob	1-1/16"	13/16" x 13/16"	1"	20	[D]
667	medium round knob	1-1/4"	13/16" x 13/16"	1-1/8"	20	[E]
667L	large round knob	1-3/8"	7/8" x 7/8"	1-1/8"	20	[F]

Pulls	Center-to-Center	Overall Length	Foot Width x Length	Projection	Inner Box	Price Code
667-3	3" CC	3-7/16"	1/2" x 3/8"	1-3/16"	20	[F]
667-96	96 mm (3-3/4") CC	4-3/16"	1/2" x 3/8"	1-3/16"	20	[G]
667-128	128 mm (5-1/16") CC	5-1/2"	1/2" x 3/8"	1-3/16"	15	[H]
667-160	160 mm (6-5/16") CC	6-3/4"	1/2" x 3/8"	1-3/16"	10	[J]
667-224	224 mm (8-13/16") CC	9-1/4"	1/2" x 3/8"	1-3/16"	10	[J]
667-305	305 mm (12") CC	12-9/16"	9/16" x 7/16"	1-1/4"	10	[K]
667-12	12" CC appl. handle	12-13/16"	3/4" x 11/16"	1-7/8"	5	[K]
667-18	18" CC appl. handle	18-13/16"	3/4" x 11/16"	1-15/16"	5	[K]

## Finishes



**BNBDL** Brushed Pewter    
 **DBAC** Rubbed Bronze    
 **NI** Polished Nickel    
 **PC** Polished Chrome    
 **SN** Satin Nickel

# Renzo

*New collection*



Knobs	Description	Overall Length	Foot Width x Length	Projection	Inner Box	Price Code
141	square knob	1-1/4"	3/4" x 3/4"	1-1/8"	10	[D]
141L	large square knob	1-3/4"	3/4" x 3/4"	1-1/8"	10	[D]

Pulls	Center-to-Center	Overall Length	Foot Width x Length	Projection	Inner Box	Price Code
141-96	96 mm (3-3/4") CC	4-5/8"	1-1/4" x 4-5/8"	1"	10	[E]
141-128	128 mm (5-1/16") CC	5-7/8"	1-1/4" x 5-7/8"	1"	10	[F]
141-160	160 mm (6-5/16") CC	7-1/8"	1-1/4" x 7-1/8"	1"	10	[G]
141-192	192 mm (7-9/16") CC	8-3/8"	1-1/4" x 8-3/8"	1"	10	[H]
141-305	305 mm (12") CC	12-7/8"	1-1/4" x 12-7/8"	1"	10	[K]

## Finishes



**BG**  
Brushed  
Gold

**BNBDL**  
Brushed  
Pewter

**DBAC**  
Brushed Oil  
Rubbed Bronze

**MB**  
Matte Black

**PC**  
Polished  
Chrome

**SBZ**  
Satin  
Bronze

**SN**  
Satin  
Nickel



## Debonair

Thoughtfully balanced lines blend with a boldly stepped profile in Jeffrey Alexander's Renzo, resulting in a strong and debonair presence. Revitalizing the admired cup pull with its modern squared shape, this adaptable collection enhances the look of almost any cabinet style while adding functionality with its dual-hole mounting options.



Shown in Satin Bronze

**Center mount:**  
use when the mounting  
holes are positioned in the  
center of the drawer front



**Lower mount:**  
use when the mounting  
holes are positioned lower  
on the drawer front



847-96DBAC



847-160SN



847-160MB



847-128PC



847-128BNBDL

Pulls	Center-to-Center	Overall Length	Foot Width x Length	Projection	Inner Box	Price Code
847-96	96 mm (3-3/4") CC	5-9/16"	5/8" x 1-1/4"	7/8"	25	[D]
847-128	128 mm (5-1/16") CC	6-13/16"	5/8" x 1-1/4"	7/8"	25	[D]
847-160	160 mm (6-5/16") CC	8-1/16"	5/8" x 1-1/4"	7/8"	25	[D]

## Finishes



**BNBDL**  
Brushed Pewter



**DBAC**  
Brushed Oil  
Rubbed Bronze



**MB**  
Matte Black



**PC**  
Polished Chrome



**SN**  
Satin Nickel



Knobs	Description	Overall Length	Foot Width x Length	Projection	Inner Box	Price Code
431	soft square knob	1-3/16"	9/16" x 9/16"	15/16"	30	[D]
595	pyramid knob	1-1/4"	5/8" x 5/8"	7/8"	20	[D]

Pulls	Center-to-Center	Overall Length	Foot Width x Length	Projection	Inner Box	Price Code
798-96	96 mm (3-3/4") CC	5-1/2"	9/16" x 1"	1"	10	[E]
798-128	128 mm (5-1/16") CC	6-3/4"	9/16" x 1"	1"	10	[F]
798-160	160 mm (6-5/16") CC	8-1/16"	9/16" x 1"	1"	10	[G]

**Finishes**



**BNBDL**  
Brushed Pewter



**DBAC**  
Brushed Oil  
Rubbed Bronze



**PC**  
Polished Chrome



**SN**  
Satin Nickel

# Roman

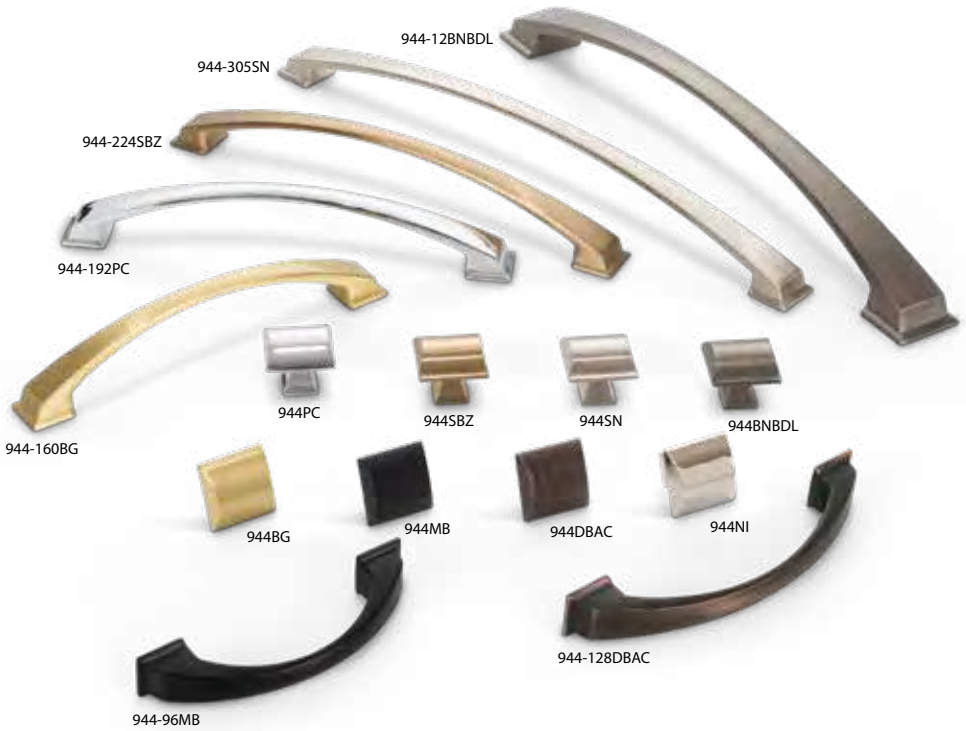

Knobs	Description	Overall Length	Foot Width x Length	Projection	Inner Box	Price Code
944	square knob	1-1/4"	5/8" x 5/8"	1-1/8"	20	[D]
Pulls	Center-to-Center	Overall Length	Foot Width x Length	Projection	Inner Box	Price Code
944-96	96 mm (3-3/4") CC	4-15/16"	13/16" x 13/16"	1-7/16"	10	[E]
944-128	128 mm (5-1/16") CC	6-1/4"	7/8" x 7/8"	1-7/16"	10	[F]
944-160	160 mm (6-5/16") CC	7-1/2"	7/8" x 7/8"	1-7/16"	10	[F]
944-192	192 mm (7-9/16") CC	8-3/4"	15/16" x 7/8"	1-7/16"	10	[G]
944-224	224 mm (8-13/16") CC	10"	15/16" x 7/8"	1-1/2"	15	[H]
944-305	305 mm (12") CC	13-3/16"	15/16" x 7/8"	1-9/16"	10	[K]
944-12	12" CC appliance handle	13-5/8"	1-3/8" x 1-3/16"	1-7/8"	5	[K]

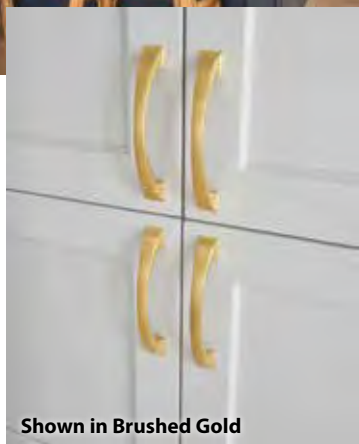

Shown in Brushed Gold

## Inspiring

A flowing arch and strong structured foot make an inspiring and compelling combination for this knob and pull collection. The high arch of Roman's pull discreetly adds the additional hand clearance for Aging in Place projects require while presenting a refined look.

### Finishes



**BG**  
Brushed  
Gold



**BNBDL**  
Brushed  
Pewter



**DBAC**  
Brushed  
Oil Rubbed  
Bronze



**MB**  
Matte Black



**NI**  
Polished  
Nickel



**PC**  
Polished  
Chrome



**SBZ**  
Satin Bronze



**SN**  
Satin Nickel



Shown in Matte Black

## Substantial

Sonoma's substantial-profile combined with a soft curve and coordinating sleek square knob exude understated elegance. Pair this collection with slab drawers and Shaker cabinets for an accomplished look.

### *Design Idea*

Modernize your white cabinets by adding contrasting black hardware.





Knobs	Description	Overall Length	Foot Width x Length	Projection	Inner Box	Price Code
431	soft square knob	1-3/16"	9/16" x 9/16"	15/16"	30	[D]

Pulls	Center-to-Center	Overall Length	Foot Width x Length	Projection	Inner Box	Price Code
4128	128 mm (5-1/16") CC	6-3/16"	5/8" x 3/4"	1-1/8"	20	[F]
4160	160 mm (6-5/16") CC	8"	11/16" x 1"	1-3/16"	20	[G]
4192	192 mm (7-9/16") CC	9-1/2"	11/16" x 1-1/4"	1-3/16"	20	[H]
4288	288 mm (11-5/16") CC	14-7/16"	13/16" x 1-3/4"	1-1/4"	10	[K]

## Finishes



**BNBDL**  
Brushed Pewter



**DBAC**  
Brushed Oil  
Rubbed Bronze



**MB**  
Matte Black



**PC**  
Polished Chrome



**SN**  
Satin Nickel

# Sullivan



Knobs	Description	Overall Length	Foot Width x Length	Projection	Inner Box	Price Code
752-19	19 mm (3/4") CC knob	1-1/4"	3/4" x 1-1/4"	1-1/16"	25	[D]

Pulls	Center-to-Center	Overall Length	Foot Width x Length	Projection	Inner Box	Price Code
752-96	96 mm (3-3/4") CC	4-1/2"	3/4" x 3/4"	1-3/16"	20	[D]
752-128	128 mm (5-1/16") CC	5-13/16"	3/4" x 3/4"	1-3/16"	10	[F]
752-160	160 mm (6-5/16") CC	7-1/16"	3/4" x 3/4"	1-3/16"	10	[G]
752-192	192 mm (7-9/16") CC	8-5/16"	3/4" x 3/4"	1-3/16"	10	[G]
752-224	224 mm (8-13/16") CC	9-9/16"	3/4" x 3/4"	1-3/16"	10	[H]



## Powerful

Reflecting the brawn of I-beams softened by gentle undercurves and tapered feet, Sullivan radiates a powerful yet serene presence. With a coordinating knob that echoes the pull's strong silhouette, this collection is adaptable to raised or flat panel cabinets.



Shown in Brushed Pewter

### Finishes



**BNBDL**

Brushed Pewter



**DBAC**

Brushed Oil  
Rubbed Bronze



**MB**

Matte Black



**PC**

Polished Chrome



**SN**

Satin Nickel



Shown in Brushed Gold

## Warm

Sutton's square profile is softened with a warm and graceful curve that flows around the handgrip all the way down to its feet.

The narrow design of these pulls can make both a fearless statement or whisper sophistication with the perfect finish choice.



Pulls	Center-to-Center	Overall Length	Foot Width x Length	Projection	Inner Box	Price Code
635-32	32 mm (1-1/4") CC	2-1/4"	5/16" x 11/16"	1"	30	[E]
635-96	96 mm (3-3/4") CC	4-3/4"	5/16" x 13/16"	1-1/16"	25	[F]
635-128	128 mm (5-1/16") CC	5-7/8"	5/16" x 13/16"	1-1/16"	20	[F]
635-160	160 mm (6-5/16") CC	7-1/2"	3/8" x 7/8"	1-1/16"	10	[G]
635-256	256 mm (10-1/16") CC	11-7/16"	3/8" x 1"	1-1/8"	20	[K]

## Finishes



**BG**  
Brushed Gold



**BNBDL**  
Brushed Pewter



**DBAC**  
Brushed Oil  
Rubbed Bronze



**MB**  
Matte Black



**NI**  
Polished Nickel



**PC**  
Polished Chrome



**SBZ**  
Satin Bronze



**SN**  
Satin Nickel

# Tahoe

US Patent #  
D602,330; D598,270



Knobs	Description	Overall Length	Foot Width x Length	Projection	Inner Box	Price Code
602S	small square knob	1-1/4"	9/16" x 9/16"	1-3/16"	30	[G]
602	large square knob	1-1/2"	9/16" x 9/16"	1-1/4"	25	[G]

Pulls	Center-to-Center	Overall Length	Foot Width x Length	Projection	Inner Box	Price Code
602-96	96 mm (3-3/4") CC	4-1/2"	3/4" x 3/4"	1-5/16"	10	[H]
602-128	128 mm (5-1/16") CC	5-13/16"	3/4" x 3/4"	1-3/8"	10	[J]
602-12	12" CC appliance handle	12-3/4"	3/4" x 3/4"	1-3/8"	5	[K]

## Finishes



**BLK**  
Black



**DMAC**  
Distressed Oil  
Rubbed Bronze



**SIM**  
Distressed Antique  
Silver



## Rugged

Tahoe features the strength and breathtaking appeal of a mountain range with a rugged twist on a robust and modern silhouette. A great choice to add rustic charm to rich, wood tone cabinets or a modern farmhouse feel to white cabinets.

### *Design Idea*

Rustic style paired with clean, white Shaker cabinets creates a look that will stand the test of time.



Shown in Black



Shown in Polished Nickel

## Elegant

Tiffany combines a classically elegant shape with a transitional twist for a look that is timeless. This pull and knob collection features matching step details throughout the hardware design, accompanied by flowing curves for a comfortable feel in your hand.

### Finishes



**BG**  
Brushed Gold



**BNBDL**  
Brushed  
Pewter



**DBAC**  
Brushed Oil  
Rubbed Bronze



**NI**  
Polished  
Nickel



**PC**  
Polished  
Chrome



**SBZ**  
Satin Bronze



**SN**  
Satin Nickel



# Tiffany

US Patent #  
D792,188



Knobs	Description	Diameter	Foot Width x Length	Projection	Inner Box	Price Code
658	round knob	1-1/4"	7/8" x 7/8"	1-5/16"	20	[F]
Pulls	Center-to-Center	Overall Length	Foot Width x Length	Projection	Inner Box	Price Code
658-96	96 mm (3-3/4") CC	4-1/2"	3/4" x 3/4"	1-5/16"	20	[G]
658-128	128 mm (5-1/16") CC	5-13/16"	3/4" x 3/4"	1-5/16"	15	[H]
658-160	160 mm (6-5/16") CC	7-1/16"	3/4" x 3/4"	1-3/8"	10	[J]
658-192	192 mm (7-9/16") CC	8-3/8"	13/16" x 13/16"	1-3/8"	15	[J]
658-224	224 mm (8-13/16") CC	9-7/8"	7/8" x 7/8"	1-1/2"	15	[K]
658-12	12" CC appliance handle	13"	1" x 1"	2"	5	[K]

# Wheeler



Knobs	Description	Overall Length	Foot Width x Length	Projection	Inner Box	Price Code
678	geometric knob	1-1/4"	3/4" x 3/4"	1-3/16"	20	[D]

Pulls	Center-to-Center	Overall Length	Foot Width x Length	Projection	Inner Box	Price Code
678-96	96 mm (3-3/4") CC	5"	13/16" x 13/16"	1-1/16"	10	[F]
678-128	128 mm (5-1/16") CC	6-1/4"	13/16" x 13/16"	1-1/16"	10	[G]
678-160	160 mm (6-5/16") CC	7-1/2"	13/16" x 13/16"	1-1/16"	10	[G]
678-18	18" CC appliance handle	20-1/4"	1-3/8" x 1-3/8"	2"	5	[K]

## Finishes



**BG** Brushed Gold   
**BNBDL** Brushed Pewter   
**DBAC** Brushed Oil Rubbed Bronze   
**MB** Matte Black   
**PC** Polished Chrome   
**SBZ** Satin Bronze   
**SN** Satin Nickel



Shown in Brushed Gold

## Enchanting

Controlled lines following a gentle contour result in an enchanting union of beauty and style. Wheeler offers meticulously styled pulls paired with a brilliantly angled octagon knob to dress up any kitchen, bathroom, or closet.



Shown in Brushed Pewter

## Unexpected

The square bar pull structure with dashing strap detail of Zane is an unexpected and charming transformation from the basic bar or square bar pull. Available in extended pull lengths, this collection accents any modern or transitional design scheme with its clean lines and unique presence.



Knobs	Description	Overall Length	Foot Width x Length	Projection	Inner Box	Price Code
293T	T-knob	2"	5/16" x 5/16"	1-1/4"	10	[E]

Pulls	Center-to-Center	Overall Length	Foot Width x Length	Projection	Inner Box	Price Code
293-96	96 mm (3-3/4") CC	5"	5/16" x 5/16"	1-1/4"	10	[G]
293-128	128 mm (5-1/16") CC	6-5/16"	5/16" x 5/16"	1-1/4"	10	[G]
293-160	160 mm (6-5/16") CC	7-9/16"	5/16" x 5/16"	1-1/4"	10	[H]
293-192	192 mm (7-9/16") CC	8-13/16"	5/16" x 5/16"	1-1/4"	10	[H]
293-224	224 mm (8-13/16") CC	10-1/16"	5/16" x 5/16"	1-1/4"	10	[J]
293-305	305 mm (12") CC	13-1/4"	5/16" x 5/16"	1-1/4"	10	[K]

## Finishes



**BNBDL**  
Brushed Pewter



**MB**  
Matte Black



**NI**  
Polished Nickel



**PC**  
Polished Chrome



**SN**  
Satin Nickel

# The **essentials** and more, priced right



Knox Collection on pages 100-101

40+ designs of knobs and pulls in the most popular styles and finishes

Complete line of solid steel and hollow stainless steel bar pulls available in the Naples collection

Base Metal of cast zinc alloy, steel, aluminum or stainless steel for durability

Machine polished for consistent quality

Limited Lifetime Warranty



Pulls	Center-to-Center	Overall Length	Foot Width x Length	Projection	Inner Box	Price Code
193-3	3" CC	3-1/4"	3/4" x 1/4"	1-1/8"	15	[D]
193-96	96 mm (3-3/4") CC	4"	3/4" x 1/4"	1-1/8"	15	[D]
193-4	4" CC	4-1/4"	3/4" x 1/4"	1-1/8"	15	[E]
193-128	128 mm (5-1/16") CC	5-1/4"	3/4" x 1/4"	1-1/8"	10	[E]
193-160	160 mm (6-5/16") CC	6-1/2"	3/4" x 1/4"	1-1/8"	10	[F]

## Finishes

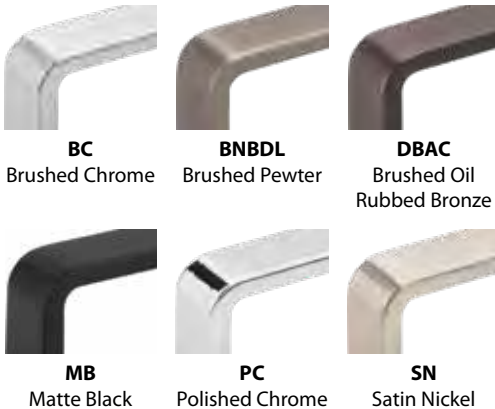



Shown in Brushed Oil Rubbed Bronze

## Charming

Charming and welcoming, Aiden offers a comfortable grip and ample hand clearance with its flowing arch profile. With its coordinating knob and extended sizes, this collection is a favorable choice for universal design needs.

### *Design Idea*

For mudrooms, closets and bathrooms, pair your cabinet knobs and pulls with Elements decorative hooks in the same finish for a cohesive look with added organization.





Knobs	Description	Overall Length	Foot		Inner Box	Price Code
			Width x Length	Projection		
993	T-knob	1-5/8"	1/2" x 1/2"	1-1/16"	30	[B]

Pulls	Center-to-Center	Overall Length	Foot		Inner Box	Price Code
			Width x Length	Projection		
993-3	3" CC	4-1/16"	3/8" x 11/16"	1-1/4"	25	[D]
993-96	96 mm (3-3/4") CC	4-3/4"	3/8" x 11/16"	1-1/4"	20	[D]
993-128	128 mm (5-1/16") CC	6-1/8"	7/16" x 11/16"	1-1/4"	15	[E]

## Finishes



**BNBDL**  
Brushed Pewter



**DBAC**  
Brushed Oil  
Rubbed Bronze



**PC**  
Polished Chrome



**SN**  
Satin Nickel



Pulls	Center-to-Center	Overall Length	Foot Width x Length	Projection	Inner Box	Price Code
308-128	128 mm (5-1/16") CC	5-9/16"	3/8" x 9/16"	15/16"	25	[D]
406-128	128 mm (5-1/16") CC	6-9/16"	5/16" x 5/16"	1-1/4"	20	[E]
745-128	128 mm (5-1/16") CC	5-11/16"	5/8" x 5/8"	1-3/16"	20	[D]
776-128	128 mm (5-1/16") CC	5-11/16"	5/8" x 1/2"	1-3/16"	20	[E]
976-128	128 mm (5-1/16") CC	6-3/16"	1-3/16" x 11/16"	1-1/16"	20	[E]

## Finishes



**BLK**  
Matte Black



**DN**  
Dull Nickel



**PC**  
Polished Chrome



**SN**  
Satin Nickel



Knobs	Description	Diameter	Foot Width x Length	Projection	Inner Box	Price Code
239	round knob	1"	3/8" x 5/8"	1"	30	[B]

Pulls	Center-to-Center	Overall Length	Foot Width x Length	Projection	Inner Box	Price Code
239-96	96 mm (3-3/4") CC	4-5/16"	1/2" x 1/2"	1-1/8"	15	[D]
239-128	128 mm (5-1/16") CC	5-9/16"	1/2" x 1/2"	1-1/8"	15	[E]
239-160	160 mm (6-5/16") CC	6-13/16"	1/2" x 1/2"	1-1/8"	15	[F]
239-192	192 mm (7-9/16") CC	8-1/16"	1/2" x 1/2"	1-1/8"	10	[F]

**Finishes**



**BC**  
Brushed Chrome



**BNBDL**  
Brushed Pewter



**DACM**  
Gun Metal



**DBAC**  
Brushed Oil Rubbed Bronze



**MB**  
Matte Black



**PC**  
Polished Chrome



**SN**  
Satin Nickel



Knobs	Description	Overall Length	Foot Width x Length	Projection	Inner Box	Price Code
382	T-knob	1-1/2"	1/2" x 1/2"	1-1/8"	25	[B]

Pulls	Center-to-Center	Overall Length	Foot Width x Length	Projection	Inner Box	Price Code
382-96	96 mm (3-3/4") CC	6-1/2"	1/2" x 1-1/2"	1-1/16"	15	[E]
382-128	128 mm (5-1/16") CC	7-3/4"	1/2" x 1-1/2"	1-1/16"	10	[F]
382-160	160 mm (6-5/16") CC	9"	1/2" x 1-1/2"	1-1/16"	10	[F]

## Finishes



**BNBDL**  
Brushed Pewter



**DBAC**  
Brushed Oil Rubbed  
Bronze



**PC**  
Polished Chrome



**SN**  
Satin Nickel



Knobs	Description	Diameter	Foot Width x Length	Projection	Inner Box	Price Code
2980	round knob	1-1/4"	1" x 1"	1-1/8"	20	[C]

Pulls	Center-to-Center	Overall Length	Foot Width x Length	Projection	Inner Box	Price Code
2981	3" CC cup pull	3-11/16"	1-5/16" x 3-11/16"	1-1/8"	20	[D]

## Finishes





Shown in Matte Black

## Slim

Instantly upgrade your kitchen with this slim and sleek collection of tab pulls from Elements. Edgefield features a thin design that is the ideal choice for your contemporary home.

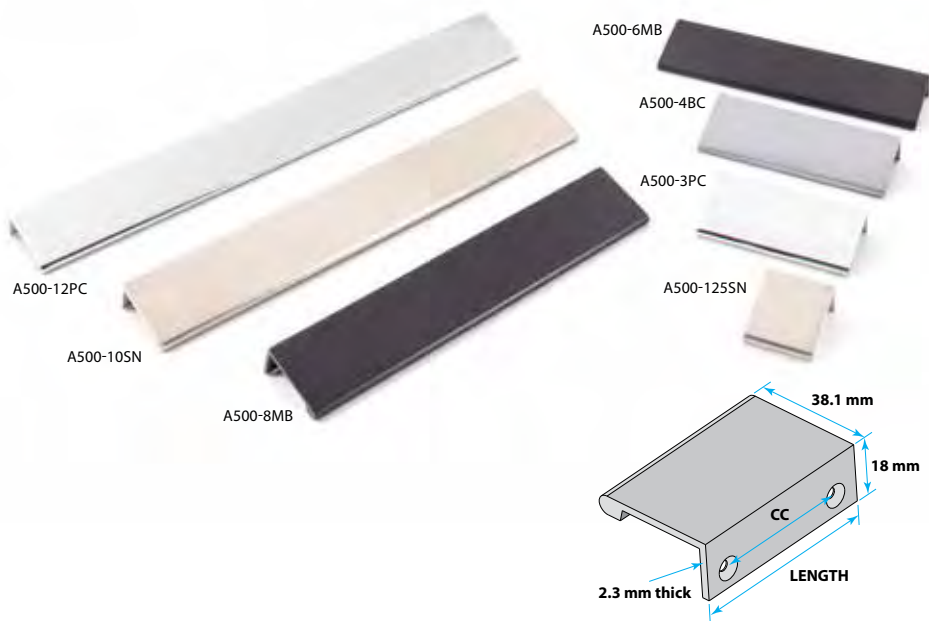

Pulls	Center-to-Center	Overall Length	Foot Width x Length	Projection	Inner Box	Price Code
A500-125*	16 mm (5/8") CC tab pull	1-1/4"	23/32" x 1-1/4"	1-1/2"	50	[B]
A500-3*	60 mm (2-3/8") CC tab pull	3"	23/32" x 3"	1-1/2"	25	[D]
A500-4*	76 mm (3") CC tab pull	4"	23/32" x 4"	1-1/2"	25	[D]
A500-6*	127 mm (5") CC tab pull	6"	23/32" x 6"	1-1/2"	20	[E]
A500-8*	90 mm (3-9/16") CC tab pull (3 holes)	8"	23/32" x 8"	1-1/2"	20	[F]
A500-10*	114 mm (4-1/2") CC tab pull (3 holes)	10"	23/32" x 10"	1-1/2"	10	[G]
A500-12*	90 mm (3-9/16") CC tab pull (4 holes)	12"	23/32" x 12"	1-1/2"	10	[H]

\*Wood screws included with all tab pulls

## Finishes



**BC**  
Brushed Chrome



**MB**  
Matte Black

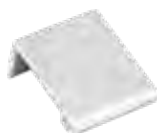

**PC**  
Polished Chrome



**SN**  
Satin Nickel

# Gibson



Knobs	Description	Diameter	Foot Width x Length	Projection	Inner Box	Price Code
105	round knob	1-1/4"	7/16" x 7/16"	1"	10	[C]

Pulls	Center-to-Center	Overall Length	Foot Width x Length	Projection	Inner Box	Price Code
105-96	96 mm (3-3/4") CC	4-1/4"	7/16" x 7/16"	1-1/8"	10	[D]
105-128	128 mm (5-1/16") CC	5-1/2"	7/16" x 7/16"	1-1/8"	10	[D]
105-160	160 mm (6-5/16") CC	6-3/4"	7/16" x 7/16"	1-1/8"	10	[E]
105-192	192 mm (7-9/16") CC	8"	7/16" x 7/16"	1-1/8"	10	[F]

## Finishes



**BG**  
Brushed Gold



**BNBDL**  
Brushed Pewter



**MB**  
Matte Black



**PC**  
Polished Chrome



**SBZ**  
Satin Bronze



**SN**  
Satin Nickel



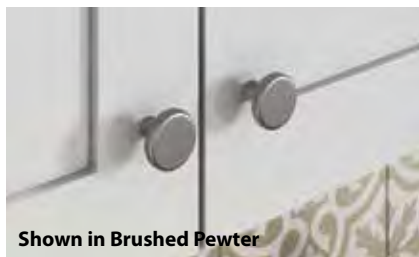

Shown in Brushed Pewter

## Harmonic

Gibson, with its clean, casual lines, brings an effortless, harmonic vibe to your contemporary or transitional space. A coordinating smooth and simplistic 1-1/4" diameter cabinet knob pairs melodiously with its cabinet pull. The standard pull features soft outer curves and straight lines that flow into cylindrical feet producing an easy-going feel. This closed-end bar pull collection is a crowd-pleaser.



Shown in Matte Black

## Fun

Fun and lively, a soft square silhouette is echoed in Hadly's pull and knob. Flourishing quickly into a crowd favorite, extended lengths and finishes have been added to deepen its appeal.

### *Design Idea*

Black and gold accents add so much personality to a predominantly white space. Don't be afraid to pair matte black hardware with gold accents to add pizzazz to your kitchen or bathroom.

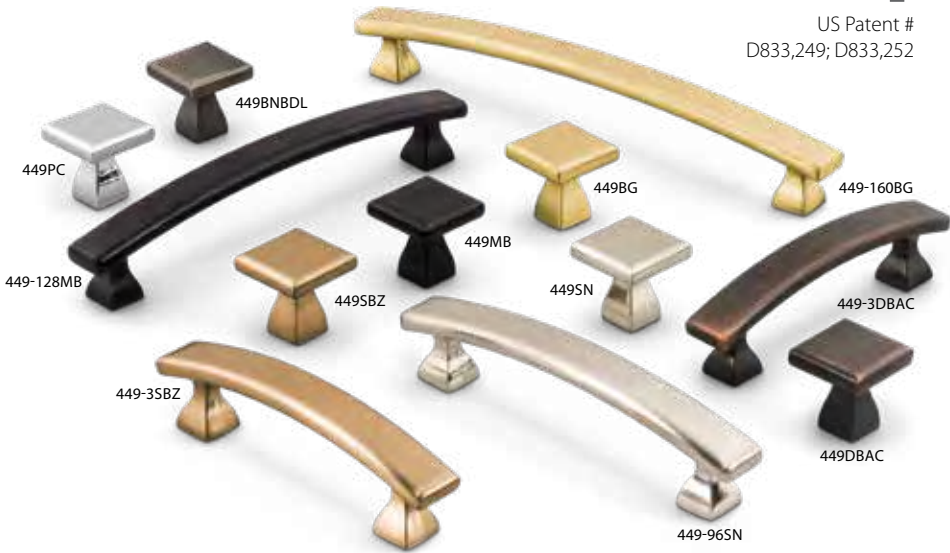

Knobs	Description	Overall Length	Foot Width x Length	Projection	Inner Box	Price Code
449	square knob	1"	1/2" x 1/2"	1"	25	[C]

Pulls	Center-to-Center	Overall Length	Foot Width x Length	Projection	Inner Box	Price Code
449-3	3" CC	4"	1/2" x 1/2"	1-1/8"	15	[D]
449-96	96 mm (3-3/4") CC	4-3/4"	1/2" x 1/2"	1-1/8"	15	[D]
449-128	128 mm (5-1/16") CC	6"	1/2" x 1/2"	1-1/8"	10	[E]
449-160	160 mm (6-5/16") CC	7-1/4"	1/2" x 1/2"	1-1/8"	10	[F]

## Finishes



**BG**  
Brushed Gold



**BNBDL**  
Brushed Pewter



**DBAC**  
Brushed Oil  
Rubbed Bronze



**MB**  
Matte Black



**PC**  
Polished Chrome



**SBZ**  
Satin Bronze



**SN**  
Satin Nickel



Knobs	Description	Overall Length	Foot Width x Length	Projection	Inner Box	Price Code
525	square knob	1-1/8"	1/4" x 1/4"	15/16"	50	[C]
Pulls	Center-to-Center	Overall Length	Foot Width x Length	Projection	Inner Box	Price Code
525-96	96 mm (3-3/4") CC	4-15/16"	15/16" x 13/16"	15/16"	25	[D]

## Finishes





Knobs	Description	Overall Length	Foot Width x Length	Projection	Inner Box	Price Code
525	square knob	1-1/8"	1/4" x 1/4"	15/16"	50	[C]

Pulls	Center-to-Center	Overall Length	Foot Width x Length	Projection	Inner Box	Price Code
937-3	3" CC	4-7/8"	9/16" x 1-1/16"	15/16"	20	[B]
937-96	96 mm (3-3/4") CC	5-11/16"	9/16" x 1-1/16"	15/16"	20	[D]

## Finishes



**BNBDL**  
Brushed Pewter



**DBAC**  
Brushed Oil  
Rubbed Bronze



**MB**  
Matte Black

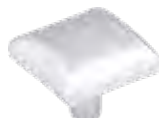

**PC**  
Polished Chrome



**SN**  
Satin Nickel



Pulls	Center-to-Center	Overall Length	Foot Width x Length	Projection	Inner Box	Price Code
645-96	96 mm (3-3/4") CC	4-1/4"	5/16" x 15/16"	1-3/8"	10	[E]
645-128	128 mm (5-1/16") CC	5-9/16"	5/16" x 15/16"	1-3/8"	10	[F]
645-160	160 mm (6-5/16")	6-13/16"	5/16" x 15/16"	1-3/8"	10	[F]
645-192	192 mm (7-9/16")	8-1/16"	5/16" x 15/16"	1-3/8"	10	[G]
645-224	224 mm (8-13/16")	9-5/16"	5/16" x 15/16"	1-3/8"	10	[G]
645-320	320 mm (12-5/8") CC	13-1/16"	5/16" x 15/16"	1-3/8"	10	[H]

## Finishes



**MB**  
Matte Black



**PC**  
Polished Chrome



**SN**  
Satin Nickel



Shown in Matte Black

## Subtle

A subtle reflection of a warded lock key, Knox pairs leading lines and intentional curves for a simple yet distinctive look. This closed-ended bar pull series offers a generous 1" hand clearance for an aesthetically pleasing option for Aging in Place projects.

### *Design Idea*

When choosing hardware, think about how often your drawers or doors are used, as well as who the user is. Longer pulls and pulls with a larger hand clearance are easier to grab, especially for users with limited hand mobility.



Knobs	Description	Diameter	Foot Width x Length	Projection	Inner Box	Price Code
3970	round knob	1-1/4"	3/4" x 3/4"	1-1/16"	25	[A]

Pulls	Center-to-Center	Overall Length	Foot Width x Length	Projection	Inner Box	Price Code
254-3	3" CC	5"	11/16" x 1-1/8"	15/16"	20	[B]
254-96	96 mm (3-3/4") CC	5-3/4"	11/16" x 1-1/8"	15/16"	20	[D]

## Finishes



**BNBDL**  
Brushed Pewter



**DBAC**  
Brushed Oil  
Rubbed Bronze



**MB**  
Matte Black



**PC**  
Polished Chrome



**SN**  
Satin Nickel





Knobs	Description	Diameter	Foot Width x Length	Projection	Inner Box	Price Code
3910	round knob	1-3/16"	11/16" x 11/16"	1-1/8"	30	[B]

Pulls	Center-to-Center	Overall Length	Foot Width x Length	Projection	Inner Box	Price Code
Z259-3	3" CC	3-3/8"	3/8" x 3/8"	1-1/8"	50	[B]

**Finishes**



**AB** Brushed Antique Brass    **BC** Brushed Chrome    **BG** Brushed Gold    **BN** Black Nickel    **BNBDL** Brushed Pewter    **DACM** Gun Metal    **DBAC** Brushed Oil Rubbed Bronze



**MB** Matte Black    **ORB** Dark Bronze    **PB** Polished Brass    **PC** Polished Chrome    **SB** Satin Brass    **SBZ** Satin Bronze    **SN** Satin Nickel



Knobs	Description	Overall Length	Foot Width x Length	Projection	Inner Box	Price Code
897	small oval knob	1-1/8"	9/16" x 9/16"	1-1/4"	20	[B]
897L	large oval knob	1-1/4"	5/8" x 5/8"	1-1/4"	20	[B]

Pulls	Center-to-Center	Overall Length	Foot Width x Length	Projection	Inner Box	Price Code
897-3	3" CC	5-1/8"	9/16" x 1-3/16"	1"	20	[B]

## Finishes





Knobs	Description	Overall Length	Foot Width x Length	Projection	Inner Box	Price Code
183	square knob	1"	3/8" x 1/2"	1-1/8"	25	[C]

Pulls	Center-to-Center	Overall Length	Foot Width x Length	Projection	Inner Box	Price Code
183-3	3" CC	3-3/4"	5/16" x 1/2"	1-1/8"	15	[D]
183-96	96 mm (3-3/4") CC	4-1/2"	5/16" x 1/2"	1-1/8"	15	[D]

**Finishes**



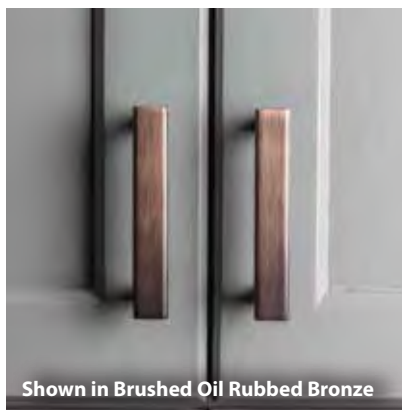

## Everlasting

This cylindrical and classic bar pull from Naples is an everlasting design, perfect for a variety of cabinet styles. Use this straight-line bar pull collection from Elements to seamlessly update cabinets and furniture, bringing a modern look to your room. Available in solid steel as well as hollow stainless steel, in a variety of lengths and finishes.



Shown in Matte Black

# Naples

## *Design Idea*

Coordinate knobs and pulls with other elements in the kitchen like faucets, door hardware, and lighting to create a cohesive look.



Shown in Brushed Gold





Knobs	Description	Overall Length	Foot Width x Length	Projection	Inner Box	Price Code
40	T-knob	1-9/16"	3/8" x 3/8"	1-3/8"	30	[B]

Pulls	Center-to-Center	Overall Length	Foot Width x Length	Projection	Inner Box	Price Code
136	3" CC	5-3/8"	3/8" x 3/8"	1-3/8"	10	[C]
156	96 mm (3-3/4") CC	6-1/8"	3/8" x 3/8"	1-3/8"	10	[D]
176	128 mm (5-1/16") CC	6-15/16"	3/8" x 3/8"	1-3/8"	10	[D]
206	128 mm (5-1/16") CC	8-1/8"	3/8" x 3/8"	1-3/8"	10	[E]
220	160 mm (6-5/16") CC	8-11/16"	3/8" x 3/8"	1-3/8"	10	[E]
272	192 mm (7-9/16") CC	10-11/16"	3/8" x 3/8"	1-3/8"	10	[E]
304	224 mm (8-13/16") CC	11-15/16"	3/8" x 3/8"	1-3/8"	10	[F]
336	256 mm (10-1/16") CC	13-1/4"	3/8" x 3/8"	1-3/8"	10	[F]
368	288 mm (11-5/16") CC	14-1/2"	3/8" x 3/8"	1-3/8"	10	[F]
399	319 mm (12-9/16") CC	15-11/16"	3/8" x 3/8"	1-3/8"	10	[G]
496	416 mm (16-3/8") CC	19-1/2"	3/8" x 3/8"	1-3/8"	10	[G]
560*	480 mm (18-7/8") CC	22-1/16"	3/8" x 3/8"	1-3/8"	10	[H]
624*	544 mm (21-7/16") CC	24-9/16"	3/8" x 3/8"	1-3/8"	10	[H]
720*	640 mm (25-3/16") CC	28-3/8"	3/8" x 3/8"	1-3/8"	10	[J]
763*	673 mm (26-1/2") CC	30-1/16"	3/8" x 3/8"	1-3/8"	10	[J]

\*Available only in Polished Chrome and Satin Nickel

## Finishes



**BG**

Brushed Gold  
(up to 416 mm CC)



**DBB** *NEW*

Dark Brushed Bronze  
(up to 416 mm CC)



**MB**

Matte Black  
(up to 416 mm CC)



**PC**

Polished Chrome  
(all lengths)



**SBZ**

Satin Bronze  
(up to 416 mm CC)



**SN**

Satin Nickel  
(all lengths)

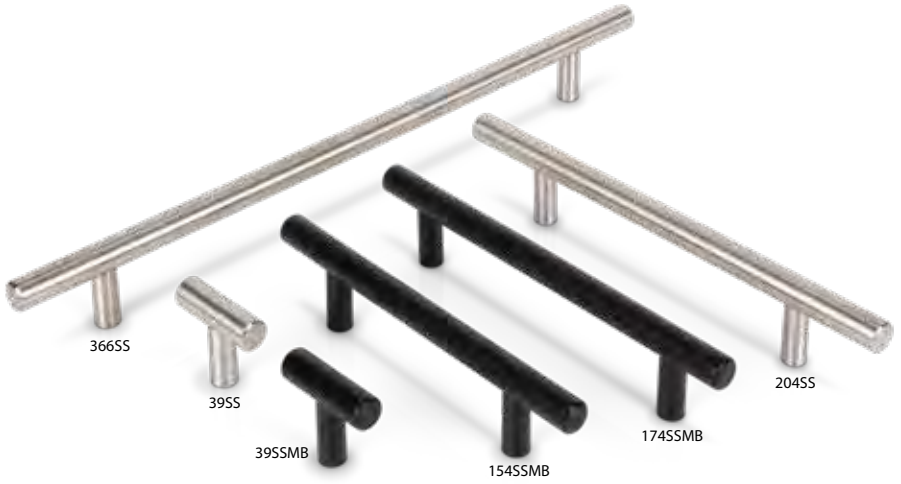

Knobs	Description	Overall Length	Foot Width x Length	Projection	Inner Box	Price Code
39	T-knob	1-9/16"	3/8" x 3/8"	1-3/8"	40	[A]

Pulls	Center-to-Center	Overall Length	Foot Width x Length	Projection	Inner Box	Price Code
154	96 mm (3-3/4") CC	6-1/16"	3/8" x 3/8"	1-3/8"	20	[C]
174	128 mm (5-1/16") CC	6-7/8"	3/8" x 3/8"	1-3/8"	20	[D]
204	128 mm (5-1/16") CC	8-1/16"	3/8" x 3/8"	1-3/8"	20	[E]
218S	160 mm (6-5/16") CC	8-9/16"	3/8" x 3/8"	1-3/8"	20	[E]
270	192 mm (7-9/16") CC	10-5/8"	3/8" x 3/8"	1-3/8"	20	[E]
302	224 mm (8-13/16") CC	11-15/16"	3/8" x 3/8"	1-3/8"	20	[E]
334	256 mm (10-1/16") CC	13-1/8"	3/8" x 3/8"	1-3/8"	20	[F]
366	288 mm (11-5/16") CC	14-7/16"	3/8" x 3/8"	1-3/8"	10	[F]
397	319 mm (12-9/16") CC	15-5/8"	3/8" x 3/8"	1-3/8"	10	[F]
494	416 mm (16-3/8") CC	19-7/16"	3/8" x 3/8"	1-3/8"	10	[G]
558	480 mm (18-7/8") CC	21-15/16"	3/8" x 3/8"	1-3/8"	10	[G]
622	544 mm (21-7/16") CC	24-1/2"	3/8" x 3/8"	1-3/8"	10	[H]
719	640 mm (25-3/16") CC	28-5/16"	3/8" x 3/8"	1-3/8"	10	[H]
761	673 mm (26-1/2") CC	29-15/16"	3/8" x 3/8"	1-3/8"	10	[H]

**Finishes**



**SS**  
Stainless Steel



**SSMB**  
Matte Black  
Stainless Steel



Knobs	Description	Diameter	Foot Width x Length	Projection	Inner Box	Price Code
511	round knob	1-1/4"	3/8" x 3/8"	1-1/8"	25	[B]

Pulls	Center-to-Center	Overall Length	Foot Width x Length	Projection	Inner Box	Price Code
511-3	3" CC	4-1/16"	5/8" x 11/16"	1-1/8"	15	[D]
511-96	96 mm (3-3/4") CC	4-7/8"	5/8" x 11/16"	1-1/8"	15	[D]

## Finishes



**BNBDL**  
Brushed Pewter



**DBAC**  
Brushed Oil Rubbed Bronze



**PC**  
Polished Chrome



**SN**  
Satin Nickel



Shown in Brushed Oil Rubbed Bronze





Knobs	Description	Diameter	Foot Width x Length	Projection	Inner Box	Price Code
26	round knob	1"	3/8" x 3/8"	15/16"	30	[B]

Pulls	Center-to-Center	Overall Length	Foot Width x Length	Projection	Inner Box	Price Code
400	3" CC	4"	5/16" x 5/16"	1-1/4"	10	[D]
475	96 mm (3-3/4") CC	4-3/4"	5/16" x 5/16"	1-1/4"	10	[E]
600	128 mm (5-1/16") CC	6"	5/16" x 5/16"	1-1/4"	10	[F]

**Finishes**



**MB**

Matte Black



**SBZ**

Satin Bronze



**SN**

Satin Nickel

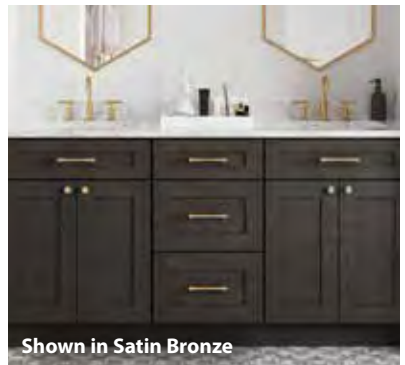

Shown in Satin Bronze



Knobs	Description	Diameter	Foot Width x Length	Projection	Inner Box	Price Code
3915	round knob	1"	11/16" x 11/16"	15/16"	50	[A]

Pulls	Center-to-Center	Overall Length	Foot Width x Length	Projection	Inner Box	Price Code
984-3	3" CC	3-5/16"	5/16" x 5/16"	7/8"	30	[C]
984-96	96 mm (3-3/4") CC	4-1/8"	5/16" x 5/16"	7/8"	25	[C]
984-128	128 mm (5-1/16") CC	5-5/16"	5/16" x 5/16"	7/8"	25	[D]
984-160	160 mm (6-5/16") CC	6-11/16"	5/16" x 5/16"	7/8"	15	[D]
984-192	192 mm (7-9/16") CC	7-7/8"	5/16" x 5/16"	7/8"	15	[E]

## Finishes



**BNBDL**  
Brushed  
Pewter



**DACM**  
Gun Metal



**DBAC**  
Brushed Oil  
Rubbed Bronze



**PC**  
Polished  
Chrome



**SN**  
Satin Nickel



**Shown in Satin Nickel**



Pulls	Center-to-Center	Overall Length	Foot Width x Length	Projection	Inner Box	Price Code
8004	96 mm (3-3/4") CC	4-15/16"	3/8" x 3/4"	1-1/16"	30	[C]
81065	128 mm (5-1/16") CC	6-1/8"	7/16" x 11/16"	1-1/8"	25	[D]
80814	96 mm (3-3/4") CC	5"	1/2" x 13/16"	7/8"	30	[B]
80815	128 mm (5-1/16") CC	6-5/16"	9/16" x 7/8"	1-1/8"	25	[D]

**Finishes**



**BNBDL**  
Brushed Pewter



**DBAC**  
Brushed Oil Rubbed Bronze



**MB**  
Matte Black



**PC**  
Polished Chrome



**SBZ**  
Satin Bronze



**SN**  
Satin Nickel



Shown in Matte Black

## Confident

Sleek, clean and confident, Stanton is a perfect alternative to the traditional rounded bar pull look. With extended lengths and six finishes to choose from, this pull series flawlessly suits all cabinet styles.



Pulls	Center-to-Center	Overall Length	Foot Width x Length	Projection	Inner Box	Price Code
625-3	3" CC	3-3/8"	3/8" x 3/8"	1-1/8"	20	[D]
625-96	96 mm (3-3/4") CC	4-1/8"	3/8" x 3/8"	1-1/8"	25	[E]
625-128	128 mm (5-1/16") CC	5-3/8"	3/8" x 3/8"	1-1/8"	20	[E]
625-160	160 mm (6-5/16") CC	6-5/8"	3/8" x 3/8"	1-1/8"	10	[F]
625-192	192 mm (7-9/16") CC	7-15/16"	3/8" x 3/8"	1-1/8"	10	[F]
625-224	224 mm (8-13/16") CC	9-3/16"	3/8" x 3/8"	1-1/8"	10	[G]
625-320	320 mm (12-5/8") CC	12-15/16"	3/8" x 3/8"	1-1/8"	10	[H]
625-448	448 mm (17-5/8") CC	18"	3/8" x 3/8"	1-1/8"	10	[J]

## Finishes



**BG**  
Brushed Gold



**MB**  
Matte Black



**MS**  
Matte Silver



**PC**  
Polished Chrome



**SBZ**  
Satin Bronze



**SN**  
Satin Nickel



771-160PC

771-128SN

771-96DBAC

771-3BNBDL

Pulls	Center-to-Center	Overall Length	Foot Width x Length	Projection	Inner Box	Price Code
771-3	3" CC	4-1/2"	5/8" x 1-3/16"	15/16"	20	[D]
771-96	96 mm (3-3/4") CC	5-3/16"	5/8" x 1-1/8"	15/16"	20	[D]
771-128	128 mm (5-1/16") CC	6-5/16"	5/8" x 1-1/8"	1"	20	[E]
771-160	160 mm (6-5/16") CC	7-11/16"	5/8" x 1-3/16"	1-1/16"	20	[F]

## Finishes



**BNBDL**

Brushed Pewter



**DBAC**

Brushed Oil  
Rubbed Bronze



**PC**

Polished Chrome



**SN**

Satin Nickel



Shown in Satin Nickel



Aluminum Pulls	Center-to-Center	Overall Length	Foot Width x Length	Foot Projection	Inner Box	Price Code
A271-3AL	3" CC	3-5/16"	5/16" x 5/16"	1-1/4"	30	[A]
A271-3.5AL	3-1/2" CC	3-13/16"	5/16" x 5/16"	1-1/4"	30	[A]
A271-96AL	96 mm (3-3/4") CC	4-1/16"	5/16" x 5/16"	1-1/4"	30	[A]
A271-4AL	4" CC	4-5/16"	5/16" x 5/16"	1-1/4"	30	[A]

Stainless Steel Pulls	Center-to-Center	Overall Length	Foot Width x Length	Foot Projection	Inner Box	Price Code
K271-3SS	3" CC	3-5/16"	5/16" x 5/16"	1-1/4"	30	[D]
K271-3.5-SS	3-1/2" CC	3-13/16"	5/16" x 5/16"	1-1/4"	30	[C]
K271-96-SS	96 mm (3-3/4") CC	4-1/16"	5/16" x 5/16"	1-1/4"	30	[C]
K271-4SS	4" CC	4-5/16"	5/16" x 5/16"	1-1/4"	30	[D]

Steel Pulls	Center-to-Center	Overall Length	Foot Width x Length	Foot Projection	Inner Box	Price Code
S271-3	3" CC	3-5/16"	5/16" x 5/16"	1-1/4"	30	[A]
S271-3.5	3-1/2" CC	3-13/16"	5/16" x 5/16"	1-1/4"	30	[A]
S271-96	96 mm (3-3/4") CC	4-1/16"	5/16" x 5/16"	1-1/4"	30	[A]
S271-4	4" CC	4-5/16"	5/16" x 5/16"	1-1/4"	30	[A]
S271-128	128 mm (5-1/16") CC	5-5/16"	5/16" x 5/16"	1-1/4"	20	[A]

**Finishes**



<b>AL</b> Aluminum	<b>BC</b> Brushed Chrome	<b>DBAC</b> Brushed Oil Rubbed Bronze	<b>MB</b> Matte Black	<b>PB</b> Polished Brass	<b>PC</b> Polished Chrome	<b>SN</b> Satin Nickel	<b>SS</b> Stainless Steel
-----------------------	-----------------------------	--	--------------------------	-----------------------------	------------------------------	---------------------------	------------------------------

# Thatcher



Knobs	Description	Overall Length	Foot Width x Length	Projection	Inner Box	Price Code
859T	T-knob	1-7/16"	5/16" x 7/16"	1-1/16"	25	[B]

Pulls	Center-to-Center	Overall Length	Foot Width x Length	Projection	Inner Box	Price Code
859-3	3" CC	5-5/16"	5/16" x 7/16"	1-1/16"	25	[C]
859-96	96 mm (3-3/4") CC	6-1/8"	5/16" x 7/16"	1-1/8"	25	[C]
859-128	128 mm (5-1/16") CC	7-1/2"	5/16" x 7/16"	1-1/8"	25	[D]
859-160	160 mm (6-5/16") CC	8-9/16"	5/16" x 7/16"	1-3/16"	25	[E]

## Finishes



**BG**  
Brushed Gold



**BNBDL**  
Brushed Pewter



**DBAC**  
Brushed Oil  
Rubbed Bronze



**MB**  
Matte Black



**PC**  
Polished Chrome



**SBZ**  
Satin Bronze



**SN**  
Satin Nickel





Shown in Brushed Gold

## Casual

A slightly round strap sitting atop the rounded feet of Thatcher creates a casual, easy-going vibe. A matching T-knob combined with extended lengths and top trending finishes make this collection the perfect match for any style of cabinets.

### *Design Idea*

For kitchens with two-tone cabinets, using the same hardware throughout is a reliable choice that ties everything together flawlessly.



Knobs	Description	Diameter	Foot Width x Length	Projection	Inner Box	Price Code
647	round knob	1-1/8"	5/8" x 5/8"	15/16"	20	[A]

Pulls	Center-to-Center	Overall Length	Foot Width x Length	Projection	Inner Box	Price Code
647-3	3" CC	4-5/8"	7/8" x 15/16"	1"	15	[B]
647-96	96 mm (3-3/4") CC	5-3/8"	7/8" x 15/16"	1"	20	[D]

## Finishes



**BNBDL**

Brushed Pewter



**DBAC**

Brushed Oil  
Rubbed Bronze



**PC**

Polished Chrome



**SN**

Satin Nickel



Shown in Brushed Oil Rubbed Bronze



Knobs	Description	Diameter	Foot Width x Length	Projection	Inner Box	Price Code
988	round knob	1-1/16"	7/16" x 7/16"	1"	25	[A]

Pulls	Center-to-Center	Overall Length	Foot Width x Length	Projection	Inner Box	Price Code
988-3	3" CC	3-3/4"	5/16" x 9/16"	1-3/16"	20	[B]
988-96	96 mm (3-3/4") CC	4-1/2"	5/16" x 9/16"	1-3/16"	20	[D]
988-128	128 mm (5-1/16") CC	5-13/16"	5/16" x 9/16"	1-1/4"	15	[D]
988-160	160 mm (6-5/16") CC	7-1/16"	5/16" x 9/16"	1-1/4"	10	[E]

**Finishes**



**BNBDL**  
Brushed Pewter



**DBAC**  
Brushed Oil  
Rubbed Bronze



**MB**  
Matte Black



**PC**  
Polished Chrome



**SN**  
Satin Nickel

# Cabinet Hardware Selection & Sizing Guide

Need some help choosing hardware for your cabinets?  
Although there are no formal rules for hardware selection, there are some guidelines you can follow that can help you select the hardware that best fits your style and budget.

## Knobs vs. Pulls

**Knobs** are smaller on the cabinets and are a suitable choice when you want to highlight the beauty of your cabinets or backsplash. They work best on cabinet doors.

**Pulls** are larger than knobs and can make a more significant statement than knobs alone. They also make opening doors/drawers easier and are available in multiple sizes to add variety and give your cabinets a more customized designer look.



You could opt for knobs on upper cabinets and pulls on lower cabinets...



...or choose all pulls for a streamlined, modern look

## Pull Sizes

Remember, there are no set rules, so choose the length that best compliments your cabinets and the level of functionality needed. **Pro Tip:** Selecting a cabinet pull that is at least  $\frac{1}{3}$  the length of the door and  $\frac{1}{3}$  to  $\frac{1}{2}$  the width of the drawer is always a safe choice.



Choosing longer cabinet pulls makes it easier to grip and access your doors and drawers, increasing the functionality of your space while creating a clean and modern, high-end look.

Pull size is  $\frac{1}{2}$  the width of the drawer

OR...

Pull size is  $\frac{1}{3}$  the width of the drawer

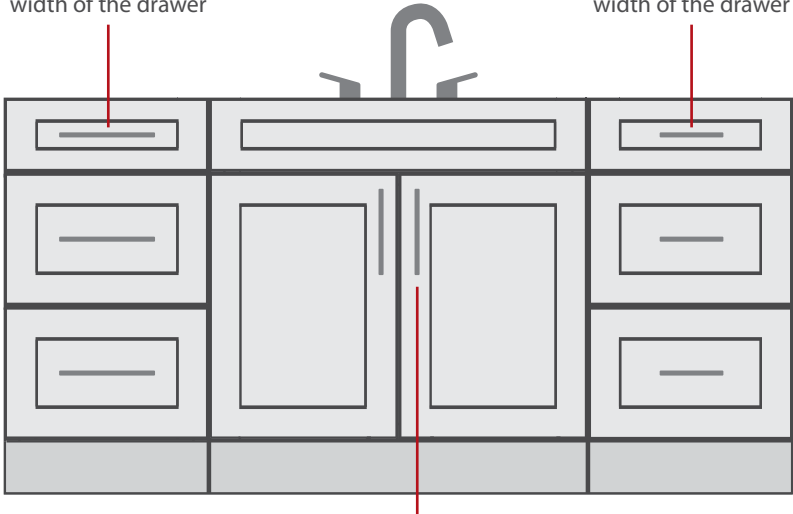

Pull size is  $\frac{1}{3}$  the height of the door



To watch a video on the length selection process, scan the QR code or visit <https://delivr.com/28cw8>

# JEFFREY ALEXANDER®

by Hardware Resources

---

## Trending finishes for our most popular collections

---



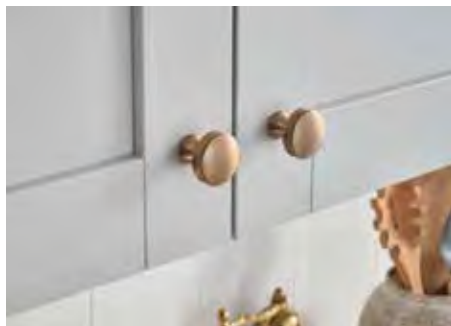

Collection	Brushed Gold (BG)	Matte Black (MB)	Satin Bronze (SBZ)	See Page(s)
Alvar		✓	✓	2-3
Annadale		✓		4-5
Audrey <i>NEW</i>	✓	✓	✓	8-9
Belcastel 1		✓	✓	10-11
Bordeaux		✓		13
Boswell		✓		14-15
Bremen 1			✓	16-17
Callie		✓	✓	22-23
Carmen	✓	✓	✓	24-25
Dominique	✓	✓	✓	30-31
Durham		✓		29
Elara		✓	✓	32-33
Hayworth	✓	✓	✓	38-39
Key Grande	✓	<i>NEW</i>		42-43
Key West & Key Largo	✓	✓	✓	44-45
Leyton		✓	✓	48-49
Lyon	✓	✓	✓	47
Marie		✓	✓	50-51
Merrick		✓	✓	54-55
Milan 1		✓		56-57
Mirada		✓		58-59
Philip	✓	✓	✓	60-61
Regan		✓		66
Renzo <i>NEW</i>	✓	✓	✓	64-65
Roman	✓	✓	✓	68-69
Sonoma		✓		70-71
Sullivan		✓		72-73
Sutton	✓	✓	✓	74-75
Tiffany	✓		✓	78-79
Wheeler	✓	✓	✓	80-81
Zane		✓		82-83

---

# Trending finishes for our most popular collections

---







<b>Collection</b>	<b>Brushed Gold (BG)</b>	<b>Matte Black (MB)</b>	<b>Satin Bronze (SBZ)</b>	<b>See Page(s)</b>
Asher		✓		85
Belfast		✓		88
Brenton		✓		89
Edgefield		✓		92-93
Florence		✓	✓	91
Gibson	✓	✓	✓	94-95
Glendale		✓	✓	98
Hadly	✓	✓	✓	96-97
Hammond		✓		99
Kenner		✓		102
Knox		✓		100-101
Madison	✓	✓	✓	103
Merryville		✓		104
Naples	✓	✓	✓	106-109
Sedona		✓	✓	111
Somerset		✓	✓	113
Stanton	✓	✓	✓	114-115
Thatcher	✓	✓	✓	118-119
Torino		✓		117
Zachary		✓		121

# Item Number Index

ITEM NUMBER	PAGE	ITEM NUMBER	PAGE	ITEM NUMBER	PAGE	ITEM NUMBER	PAGE
26	111	242	45	435-128	4	585-160	28
39	109	251	26	435-160	4	585L	28
40	108	254-3	102	435L	4	595	20, 67
48	45	254-96	102	436-96	4	595-96	20
51	42	264-3	3	436-128	4	595-128	20
105	94	264-96	3	445	51	596	42
105-96	94	264-128	3	445-12	51	600	111
105-128	94	264-160	3	445-18	51	602	76
105-160	94	264-192	3	445-96	51	602-12	76
105-192	94	270	109	445-128	51	602-96	76
117	16	272	108	445-160	51	602-128	76
127	19	274	45	445-192	51	602S	76
136	108	278	8	445-224	51	622	109
137	19	278-12	8	445-305	51	624	108
141	64	278-18	8	449	97	625-3	115
141-96	64	278-96	8	449-3	97	625-96	115
141-128	64	278-128	8	449-96	97	625-128	115
141-160	64	278-160	8	449-128	97	625-160	115
141-192	64	278-192	8	449-160	97	625-192	115
141-305	64	278-224	8	475	111	625-224	115
141L	64	278-305	8	484	33	625-320	115
146	45	278L	8	484-32	33	625-448	115
152	45	286-96	48	484-305	33	635-32	75
154	109	286-128	48	484-396	33	635-96	75
156	108	286-160	48	484-128160	33	635-128	75
165	34	286-192	48	484-192224	33	635-160	75
165-12	34	286-224	48	494	109	635-256	75
165-96	34	293-96	83	496	108	645-96	100
165-128	34	293-128	83	511	110	645-128	100
165-160	34	293-160	83	511-3	110	645-160	100
174	109	293-192	83	511-96	110	645-192	100
176	108	293-224	83	519	27	645-224	100
177-128	15	293-305	83	519-12	27	645-320	100
177-160	15	293T	83	519-18	27	647	120
177-192	15	302	109	519-96	27	647-3	120
177-224	15	304	108	519-128	27	647-96	120
178	45	308-128	88	519-160	27	650	40
183	105	317	46	525	98, 99	650-12	40
183-3	105	317-12	46	525-96	98	650-96	40
183-96	105	317-96	46	527	16	650-128	40
188	41	317-128	46	527-12	16	650-160	40
188-96	41	317-160	46	527-128	16	658	79
188-128	41	334	109	527-160	16	658-12	79
188-160	41	336	108	530	45	658-96	79
188L	41	366	109	537	19	658-128	79
193-3	85	368	108	537-12	19	658-160	79
193-4	85	370	45	537-128	19	658-192	79
193-96	85	382	90	537-160	19	658-224	79
193-128	85	382-96	90	549-96	55	667	63
193-160	85	382-128	90	549-128	55	667-3	63
204	109	382-160	90	549-160	55	667-12	63
206	108	397	109	549-192	55	667-18	63
218	46	399	108	549-320	55	667-96	63
220	108	400	111	558	109	667-128	63
239	89	406-128	88	560	108	667-160	63
239-96	89	417	46	585	28	667-224	63
239-128	89	431	67, 71	585-12	28	667-305	63
239-160	89	435	4	585-96	28	667L	63
239-192	89	435-96	4	585-128	28	667S	63

# Item Number Index

ITEM NUMBER	PAGE	ITEM NUMBER	PAGE	ITEM NUMBER	PAGE	ITEM NUMBER	PAGE
678	80	859-128	118	1092-12	56	MO6373-12	11
678-18	80	859-160	118	1092-128	56	MO6373-18	11
678-96	80	859T	118	1092-160	56	MO6373-128	11
678-128	80	867	7	2980	91	MO6373-160	11
678-160	80	867-3	7	2981	91	S271-3	117
719	109	867-96	7	3910	103	S271-3.5	117
720	108	867-128	7	3915	112	S271-4	117
722	45	867-160	7	3970	102	S271-96	117
745-128	88	867-228	7	3980	29	S271-128	117
752	72	867-320	7	3990	13	Z110	26
752-96	72	867L	7	3991	47	Z111	26
752-128	72	885	38	4128	71	Z259-3	103
752-160	72	885-96	38	4160	71	Z280	26
752-192	72	885-128	38	4192	71	Z281	26
752-224	72	885-160	38	4288	71	Z281-12	26
761	109	885-192	38	5128	42	Z281-18	26
763	108	885-224	38	5192	42	Z281-128	26
767	60	885-305	38	5224	42	Z281-160	26
767-96	60	885L	38	5319	42	Z290-3	29
767-128	60	897	104	5480	42	Z290-12	29
767-160	60	897-3	104	5673	42	Z290-96	29
771-3	116	897L	104	5900	42	Z290-128	29
771-96	116	937-3	99	8004	113	Z290-160	29
771-128	116	937-96	99	8233	47		
771-160	116	944	68	8236	13		
775	24	944-12	68	80152-96	59		
775-96	24	944-96	68	80152-128	59		
775-128	24	944-128	68	80152-160	59		
775-160	24	944-160	68	80814	113		
775L	24	944-192	68	80815	113		
776-128	88	944-224	68	81021	59		
798-96	67	944-305	68	81065	113		
798-128	67	950	45	A271-3.5AL	117		
798-160	67	972	52	A271-3AL	117		
818	12	972-12	52	A271-4AL	117		
818-12	12	972-96	52	A271-96AL	117		
818-96	12	972-128	52	A500-3	93		
818-128	12	972-160	52	A500-4	93		
818-160	12	972-224	52	A500-6	93		
818L	12	972-305	52	A500-8	93		
839-3	23	972L	52	A500-10	93		
839-96	23	972S	52	A500-12	93		
839-128	23	976-128	88	A500-125	93		
839-160	23	984-3	112	G110	37		
845	30	984-96	112	G110L	37		
845-12	30	984-128	112	G120	37		
845-18	30	984-160	112	G120L	37		
845-96	30	984-192	112	G130	37		
845-128	30	988	121	G130L	37		
845-160	30	988-3	121	G140	37		
845-192	30	988-96	121	G140L	37		
845-305	30	988-128	121	G150	37		
845T	30	988-160	121	G150L	37		
845TL	30	993	87	K271-3.5-5S	117		
847-96	66	993-3	87	K271-35S	117		
847-128	66	993-96	15, 87	K271-45S	117		
847-160	66	993-128	87	K271-96-5S	117		
859-3	118	1091	56	MO6303	11		
859-96	118	1092	56	MO6373	11		

# Available Finishes



**AB**  
Brushed  
Antique Brass

**ABM/ABM-D**  
Distressed  
Antique Brass

**ABSB**  
Antique Brushed  
Satin Brass

**AEM**  
Lightly Distressed  
Antique Brass

**AL**  
Aluminum

**BC**  
Brushed Chrome

**BG**  
Brushed Gold

**BN**  
Black Nickel

**BNBDL**  
Brushed Pewter

**BNMDL/BNDL**  
Distressed Pewter

**BLK**  
Black  
(Tahoe only)



**DACM**  
Gun Metal

**DBAC**  
Brushed Oil  
Rubbed Bronze

**DBB NEW**  
Dark Brushed  
Bronze

**DP**  
Distressed Pewter

**DMAC**  
Distressed Oil  
Rubbed Bronze

**DN**  
Dull Nickel

**MB/BLK**  
Matte Black

**MBBG NEW**  
Matte Black  
with Brushed Gold

**MBSN NEW**  
Matte Black  
with Satin Nickel

**MS**  
Matte Silver

**NI**  
Polished Nickel



**ORB**  
Dark Bronze

**PB**  
Polished Brass

**PC**  
Polished Chrome

**SB**  
Satin Brass

**SBZ**  
Satin Bronze

**SIM/SIM-D**  
Distressed  
Antique Silver

**SN**  
Satin Nickel

**SS**  
Stainless Steel

**SSMB**  
Matte Black  
Stainless Steel

All brushed and machined finishes are created by hand to add texture to the item. We hold a tight range of acceptance of color variation, however, a slight variance in the texture and tone of these items occur. We consider these variances to be minimal; slight variations are normal.

