



**HÄFELE**



**CORNERSTONE** <sup>20</sup>/<sub>22</sub>



## THIS IS THE CORNERSTONE

A curated selection of knobs and pulls so fundamental that we have created a special program just to showcase these valued best-sellers. The Cornerstone is indeed the building block of any successful cabinet or furniture decorative hardware offering. The Cornerstone combines value with quality and high-demand designs in established trending and traditional finishes. Our commitment to Cornerstone includes higher stocked quantities to ensure availability. When you need it, we will have it.

## THE CORNERSTONE STYLES

MID-CENTURY MODERN. MODERN. TRANSITIONAL. CONTEMPORARY. TRADITIONAL. MINIMALIST. ARCHITECTURAL. These are the selections and collections which make up our Cornerstone brochure. Iconic elements of each style are combined with our best-selling examples of that particular style of decorative hardware.

## HOW TO GET THE “PERFECT MATCH”

Häfele's line of TAG knobs and pulls in six must have finishes perfectly complement any project. TAG hardware's perfect finish matching for their knobs and pulls completes a look in design that is flawlessly coordinated.



## TABLE OF CONTENTS

Mid-Century Modern . . . . .	pages 1–4	Minimalist . . . . .	pages 34–44
Modern . . . . .	pages 5–13	Architectural . . . . .	pages 45–50
Transitional . . . . .	pages 14–17	Screws . . . . .	pages 51–53
Contemporary . . . . .	pages 18–30	Index . . . . .	pages 54–55
Traditional . . . . .	pages 31–33		

## Mid-Century Modern

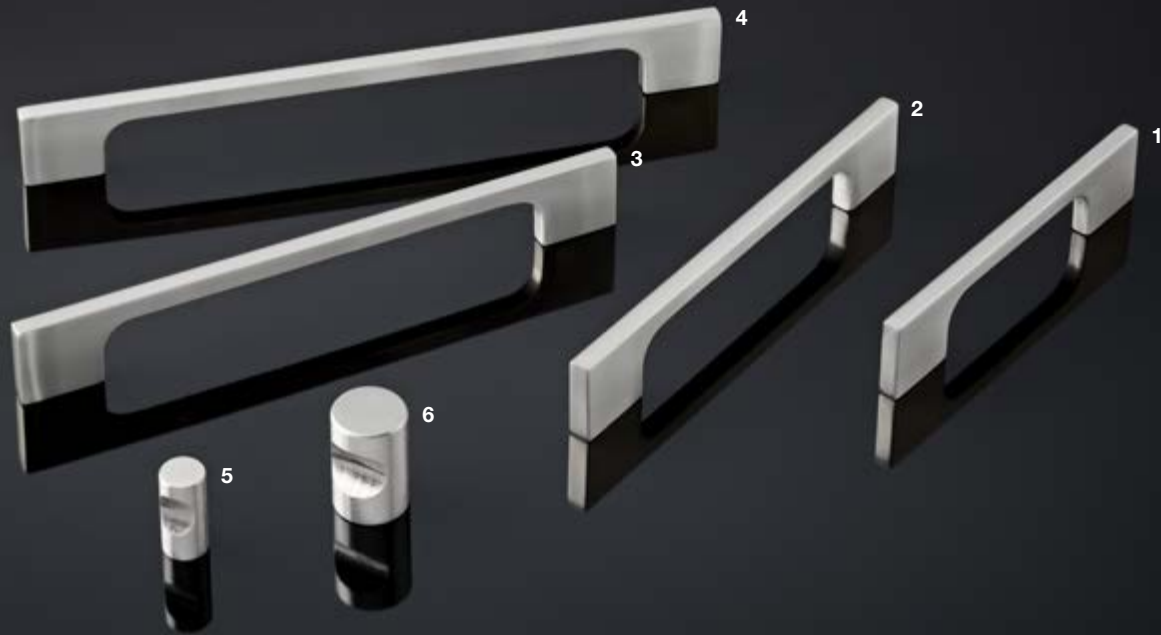

	Material	Finish	A	C	Item No.	SRP/pc.
1	Zinc	stainless steel look	116	96	111.04.114	\$4.33
2	Zinc	stainless steel look	148	128	111.04.115	\$5.40
3	Zinc	stainless steel look	180	160	111.04.116	\$5.67
4	Zinc	stainless steel look	212	192	111.04.117	\$8.02
5	Stainless Steel	matt	-	-	134.80.610	\$7.55
6	Stainless Steel	matt	-	-	134.80.629	\$11.89

1-4

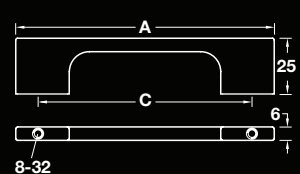

5



6

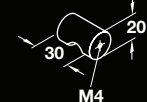

## TAG Mid-Century Modern

**Material:** Zinc

	<b>Finish</b>	<b>Item No.</b>	<b>SRP/pc.</b>
1	slate/graphite	111.95.145	\$7.72
2	polished chrome	111.95.140	\$5.84
3	matt gold	111.95.144	\$7.44
4	matt nickel	111.95.142	\$6.28
5	matt aluminum	111.95.141	\$6.28
6	black	111.95.300	\$6.28

**Note**

Tag finishes match and are ideal for use with Synergy, Synergy Elite, Engage and Signature closet accessories. See the Closet and Home Solutions catalog. Supplied with 1" mounting screws.

1-6



**Material:** Zinc

	<b>Finish</b>	<b>Item No.</b>	<b>SRP/pc.</b>
1	polished chrome	111.95.130	\$11.59
2	matt aluminum	111.95.131	\$12.80
3	matt nickel	111.95.132	\$12.80
4	black	111.95.308	\$12.80
5	matt gold	111.95.134	\$15.09
6	slate/graphite	111.95.135	\$15.65

**Note**

Tag finishes match and are ideal for use with Synergy, Synergy Elite, Engage and Signature closet accessories. See the Closet and Home Solutions catalog. Supplied with 1" mounting screws.

1-6

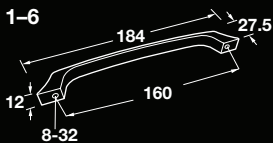

## TAG Mid-Century Modern

**Material:** Zinc

	<b>Finish</b>	<b>Item No.</b>	<b>SRP/pc.</b>
1	black	111.95.310	\$10.66
2	matt nickel	111.95.182	\$10.66
3	polished chrome	111.95.180	\$9.79
4	matt gold	111.95.184	\$12.60
5	slate/graphite	111.95.185	\$13.07
6	matt aluminum	111.95.181	\$10.66

**Note**

TAG finishes match and are ideal for use with Synergy, Synergy Elite, Engage and Signature closet accessories. See the Closet and Home Solutions catalog. Supplied with 1" mounting screws.

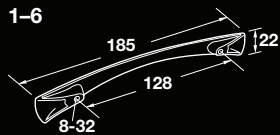

**Material:** Zinc

	<b>Finish</b>	<b>Item No.</b>	<b>SRP/pc.</b>
1	slate/graphite	111.95.175	\$5.81
2	matt gold	111.95.174	\$5.60
3	black	111.95.302	\$4.67
4	polished chrome	111.95.170	\$4.48
5	matt aluminum	111.95.171	\$4.67
6	matt nickel	111.95.172	\$4.67

**Note**

TAG finishes match and are ideal for use with Synergy, Synergy Elite, Engage and Signature closet accessories. See the Closet and Home Solutions catalog. Supplied with 1" mounting screws.

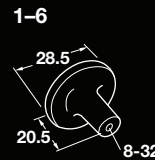

## TAG Mid-Century Modern NEW

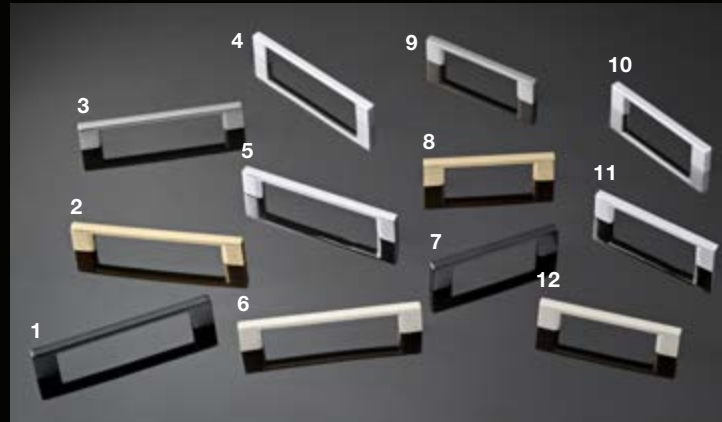

Material: Zinc

Finish	Item No.	SRP/pc.
1 black	111.95.307	\$14.71
2 matt gold	111.95.282	\$18.49
3 slate/graphite	111.95.285	\$18.49
4 matt aluminum	111.95.281	\$14.71
5 polished chrome	111.95.280	\$13.34
6 matt nickel	111.95.283	\$14.71

**Note**

TAG finishes match and are ideal for use with Synergy, Synergy Elite, Engage and Signature closet accessories. See the Closet and Home Solutions catalog. Supplied with 1" mounting screws.

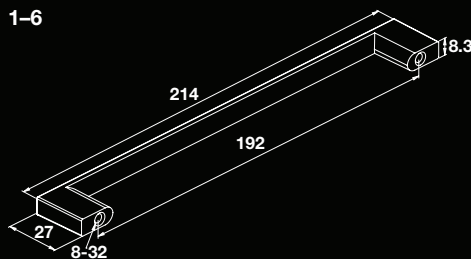

Material: Zinc

Finish	A	C	Item No.	SRP/pc.
1 black	150	128	111.95.306	\$10.45
2 matt gold	150	128	111.95.272	\$12.90
3 slate/graphite	150	128	111.95.275	\$12.90
4 matt aluminum	150	128	111.95.271	\$10.45
5 polished chrome	150	128	111.95.270	\$9.42
6 matt nickel	150	128	111.95.273	\$10.45
7 black	118	96	111.95.305	\$9.61
8 matt gold	118	96	111.95.262	\$11.92
9 slate/graphite	118	96	111.95.265	\$11.92
10 matt aluminum	118	96	111.95.261	\$9.61
11 polished chrome	118	96	111.95.260	\$8.54
12 matt nickel	118	96	111.95.263	\$9.61

**Note**

TAG finishes match and are ideal for use with Synergy, Synergy Elite, Engage and Signature closet accessories. See the Closet and Home Solutions catalog. Supplied with 1" mounting screws.

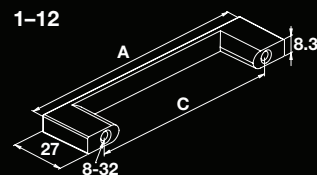

## Modern



**Material:** Zinc

	<b>Finish</b>	<b>B</b>	<b>C</b>	<b>Item No.</b>	<b>SRP/pc.</b>
1	stainless steel look	136	128	109.86.002	\$5.63
2	polished chrome	136	128	109.86.202	\$4.48
3	oil-rubbed bronze	136	128	109.86.125	\$4.23
4	stainless steel look	202	192	109.86.027	\$8.69
5	polished chrome	202	192	109.86.227	\$6.65
6	oil-rubbed bronze	202	192	109.86.127	\$7.06
7	oil-rubbed bronze	–	–	131.20.120	\$2.47
8	polished chrome	–	–	131.20.220	\$3.20
9	stainless steel look	–	–	131.20.002	\$4.08

1-6

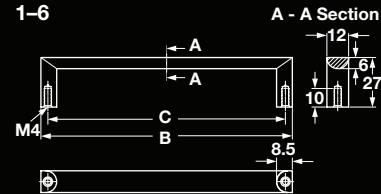

7-9

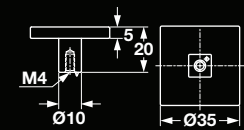



## Modern

Material: Zinc

	Finish	A	C	Item No.	SRP/pc.
1	oil-rubbed bronze	176	160	106.61.124	\$13.09
2	oil-rubbed bronze	144	128	106.61.123	\$11.32
3	polished chrome	176	160	106.61.224	\$11.83
4	polished chrome	144	128	106.61.223	\$10.08

1-4

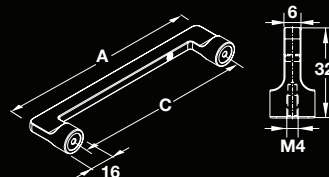

## Modern

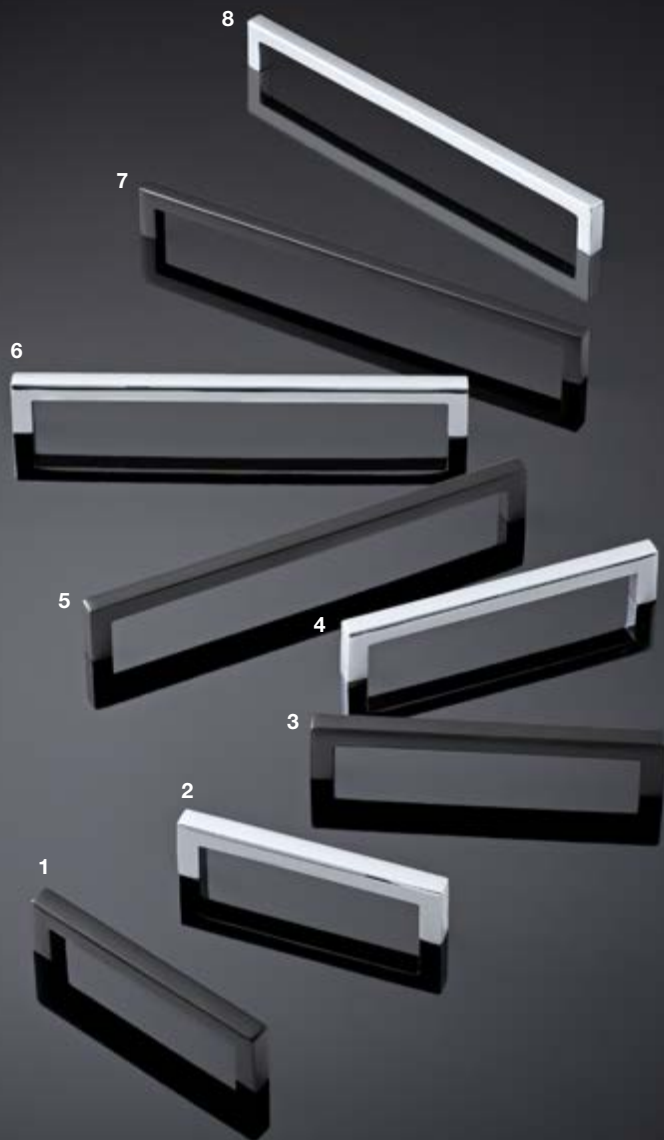

**Material:** Zinc

	<b>Finish</b>	<b>A</b>	<b>C</b>	<b>Item No.</b>	<b>SRP/pc.</b>
<b>1</b>	matt black	105	96	155.01.610	\$5.91
<b>2</b>	polished chrome	105	96	155.00.040	\$6.25
<b>3</b>	matt black	137	128	155.01.611	\$7.32
<b>4</b>	polished chrome	137	128	155.00.041	\$7.69
<b>5</b>	matt black	201	192	155.01.612	\$10.02
<b>6</b>	polished chrome	201	192	155.00.071	\$10.86
<b>7</b>	matt black	233	224	155.01.613	\$11.44
<b>8</b>	polished chrome	233	224	155.00.072	\$12.72

**1-8**

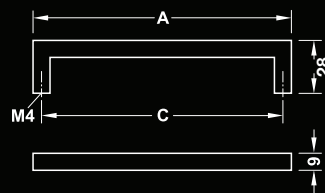

## Modern

Material: Zinc

	Finish	A	C	Item No.	SRP/pc.
1	brushed brass	105	96	155.01.620	\$6.97
2	brushed brass	137	128	155.01.621	\$8.51
3	brushed brass	201	192	155.01.622	\$11.54
4	brushed brass	233	224	155.01.623	\$13.29
5	stainless steel look	105	96	155.00.060	\$6.26
6	stainless steel look	137	128	155.00.061	\$7.69
7	stainless steel look	201	192	155.00.091	\$10.86
8	stainless steel look	233	224	155.00.092	\$12.72

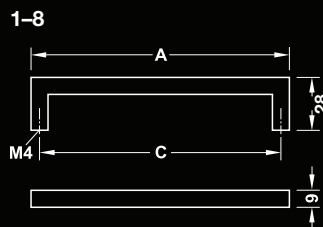

## Modern NEW

Material: Zinc

	Finish	A	C	Item No.	SRP/pc.
1	polished chrome	457	448	155.00.074	\$23.70
2	brushed brass	457	448	155.02.292	\$27.82
3	matt black	457	448	155.01.826	\$20.94
4	stainless steel	457	448	155.00.094	\$24.52
5	polished chrome	329	320	155.00.073	\$17.56
6	brushed brass	329	320	155.02.291	\$20.64
7	stainless steel	329	320	155.00.093	\$14.52
8	matt black	329	320	155.01.825	\$13.07

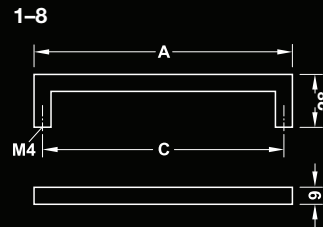

## TAG Modern NEW



Material: Zinc

Finish	Item No.	SRP/pc.
1 matt aluminum	111.95.291	\$28.38
2 polished chrome	111.95.290	\$27.32
3 matt nickel	111.95.292	\$30.08
4 slate/graphite	111.95.295	\$33.52
5 black	111.95.312	\$28.38
6 matt gold	111.95.294	\$33.52

### Note

TAG finishes match and are ideal for use with Synergy, Synergy Elite, Engage and Signature closet accessories. See the Closet and Home Solutions catalog. Supplied with 1" mounting screws.

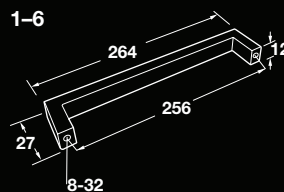

## TAG Modern

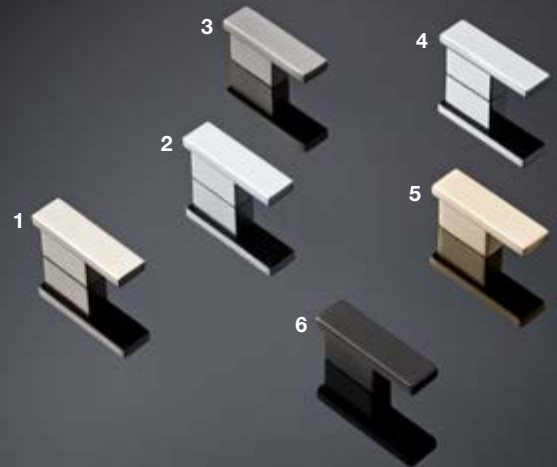

**Material:** Zinc

	Finish	Item No.	SRP/pc.
1	polished chrome	111.95.100	\$12.60
2	matt aluminum	111.95.101	\$13.67
3	matt nickel	111.95.102	\$13.67
4	black	111.95.311	\$13.67
5	slate/graphite	111.95.105	\$17.11
6	matt gold	111.95.104	\$16.50

**Note**

TAG finishes match and are ideal for use with Synergy, Synergy Elite, Engage and Signature closet accessories. See the Closet and Home Solutions catalog. Supplied with 1" mounting screws.

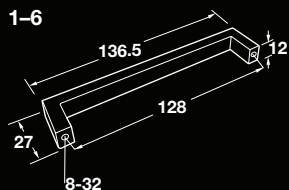

**Material:** Zinc

	Finish	Item No.	SRP/pc.
1	matt nickel	111.95.112	\$7.89
2	matt aluminum	111.95.111	\$7.89
3	slate/graphite	111.95.115	\$9.64
4	polished chrome	111.95.110	\$7.20
5	matt gold	111.95.114	\$9.30
6	black	111.95.304	\$7.89

**Note**

TAG finishes match and are ideal for use with Synergy, Synergy Elite, Engage and Signature closet accessories. See the Closet and Home Solutions catalog. Supplied with 1" mounting screws.

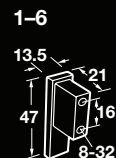

## TAG Modern

**Material:** Zinc

	<b>Finish</b>	<b>Item No.</b>	<b>SRP/pc.</b>
1	polished chrome	111.95.150	\$10.34
2	matt aluminum	111.95.151	\$11.59
3	slate/graphite	111.95.155	\$14.44
4	black	111.95.309	\$11.21
5	matt nickel	111.95.152	\$11.59
6	matt gold	111.95.154	\$13.47

**Note**

TAG finishes match and are ideal for use with Synergy, Synergy Elite, Engage and Signature closet accessories. See the Closet and Home Solutions catalog. Supplied with 1" mounting screws.

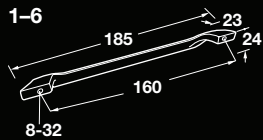

**Material:** Zinc

	<b>Finish</b>	<b>Item No.</b>	<b>SRP/pc.</b>
1	polished chrome	111.95.160	\$5.20
2	matt aluminum	111.95.161	\$5.63
3	matt nickel	111.95.162	\$5.63
4	black	111.95.301	\$5.63
5	matt gold	111.95.164	\$6.75
6	slate/graphite	111.95.165	\$7.22

**Note**

TAG finishes match and are ideal for use with Synergy, Synergy Elite, Engage and Signature closet accessories. See the Closet and Home Solutions catalog. Supplied with 1" mounting screws.

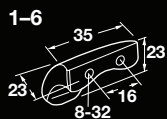

## TAG Modern



**Material:** Zinc

Finish	Item No.	SRP/pc.
1 polished chrome	111.95.120	\$13.92
2 slate/graphite	111.95.125	\$18.83
3 matt aluminum	111.95.121	\$15.33
4 matt nickel	111.95.122	\$15.33
5 black	111.95.313	\$15.33
6 matt gold	111.95.124	\$18.15

**Note**

TAG finishes match and are ideal for use with Synergy, Synergy Elite, Engage and Signature closet accessories. See the Closet and Home Solutions catalog. Supplied with 1" mounting screws.

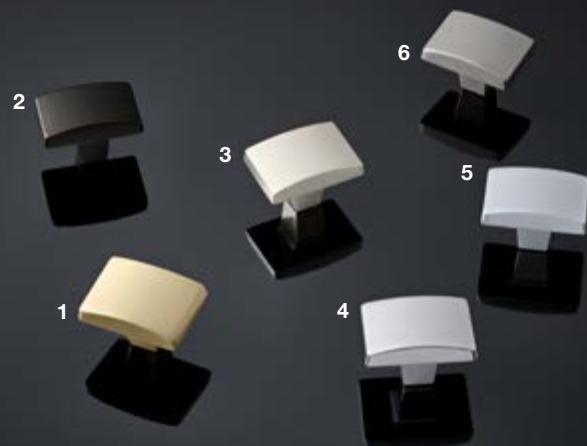
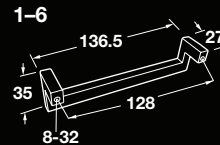

**Material:** Zinc

Finish	Item No.	SRP/pc.
1 matt gold	111.95.003	\$9.10
2 black	111.95.303	\$7.30
3 matt nickel	111.95.004	\$8.34
4 polished chrome	111.95.000	\$6.82
5 matt aluminum	111.95.001	\$7.30
6 slate/graphite	111.95.005	\$9.44

**Note**

TAG finishes match and are ideal for use with Synergy, Synergy Elite, Engage and Signature closet accessories. See the Closet and Home Solutions catalog. Supplied with 1" mounting screws.

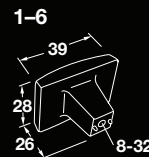



## Transitional



**Material:** Zinc

	<b>Finish</b>	<b>A</b>	<b>B</b>	<b>C</b>	<b>D</b>	<b>Item No.</b>	<b>SRP/pc.</b>
1	stainless steel look	318	33	288	39	107.18.618	\$15.67
2	oil-rubbed bronze	318	33	288	39	107.18.358	\$21.68
3	oil-rubbed bronze	152	24	128	29	107.18.353	\$4.86
4	stainless steel look	152	24	128	29	107.18.613	\$4.58
5	oil-rubbed bronze	115	19	96	24	107.18.352	\$3.37
6	stainless steel look	115	19	96	24	107.18.612	\$3.34
7	stainless steel look	–	–	–	–	134.45.030	\$3.16
8	oil-rubbed bronze	–	–	–	–	136.94.330	\$2.24

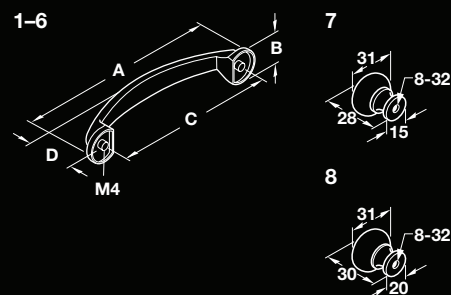

## Transitional

Material: Zinc

	Finish	A	B	C	D	Item No.	SRP/pc.
1	oil-rubbed bronze	303	25	288	48	110.18.357	\$24.34
2	stainless steel look	303	25	288	48	110.18.057	\$31.30
3	oil-rubbed bronze	140	18	128	29	125.68.352	\$6.56
4	stainless steel look	140	18	128	29	125.68.052	\$7.50
5	oil-rubbed bronze	111	15	96	29	125.68.351	\$4.47
6	stainless steel look	111	15	96	29	125.68.051	\$6.05
7	stainless steel look	–	–	–	–	133.79.051	\$5.45
8	oil-rubbed bronze	–	–	–	–	133.79.351	\$3.86

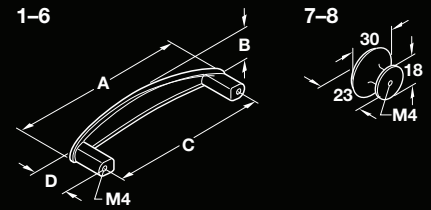

## Transitional

**Material:** Zinc

	<b>Finish</b>	<b>Screw</b>	<b>Item No.</b>	<b>SRP/pc.</b>
1	dark oil-rubbed bronze	8/32	134.06.311	\$2.60
2	matt nickel	8/32	134.06.641	\$2.72
3	satin chrome	8/32	134.06.441	\$2.82
4	matt gold	M4	155.01.819	\$2.55
5	polished chrome	M4	155.99.030	\$2.42
6	brushed nickel	M4	155.99.029	\$2.44
7	oil-rubbed bronze	M4	155.01.818	\$3.06
8	matt black	M4	155.99.028	\$2.63
9	matt chrome	M4	155.99.031	\$2.73

**Note**

4-9 supplied with 1" screws.

1-9



## Transitional **NEW**



**Material:** Zinc

**Finish**

- 1 polished chrome
- 2 stainless steel
- 3 oil-rubbed bronze
- 4 matt black
- 5 matt gold

**Item No.      SRP/pc.**

151.90.354	\$7.32
151.90.353	\$8.02
151.90.352	\$7.22
151.90.355	\$5.58
151.40.500	\$7.50

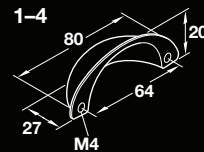

**Note**

Supplied with screws.

## Contemporary

	Material	Finish	A	C	Item No.	SRP/pc.
1	Aluminum	matt aluminum	126	96	155.00.980	\$44.24
2	Aluminum	matt aluminum	158	128	155.00.981	\$51.24
3	Aluminum	matt aluminum	190	160	155.00.982	\$49.28
4	Aluminum	matt aluminum	222	192	155.00.983	\$59.60
5	Aluminum/Zinc	matt aluminum/black	188	160	111.95.063	\$20.18
6	Aluminum/Zinc	matt aluminum/black	412	384	111.95.069	\$27.14

### Note

1-4 with loose base, 2 fixing options of handle.

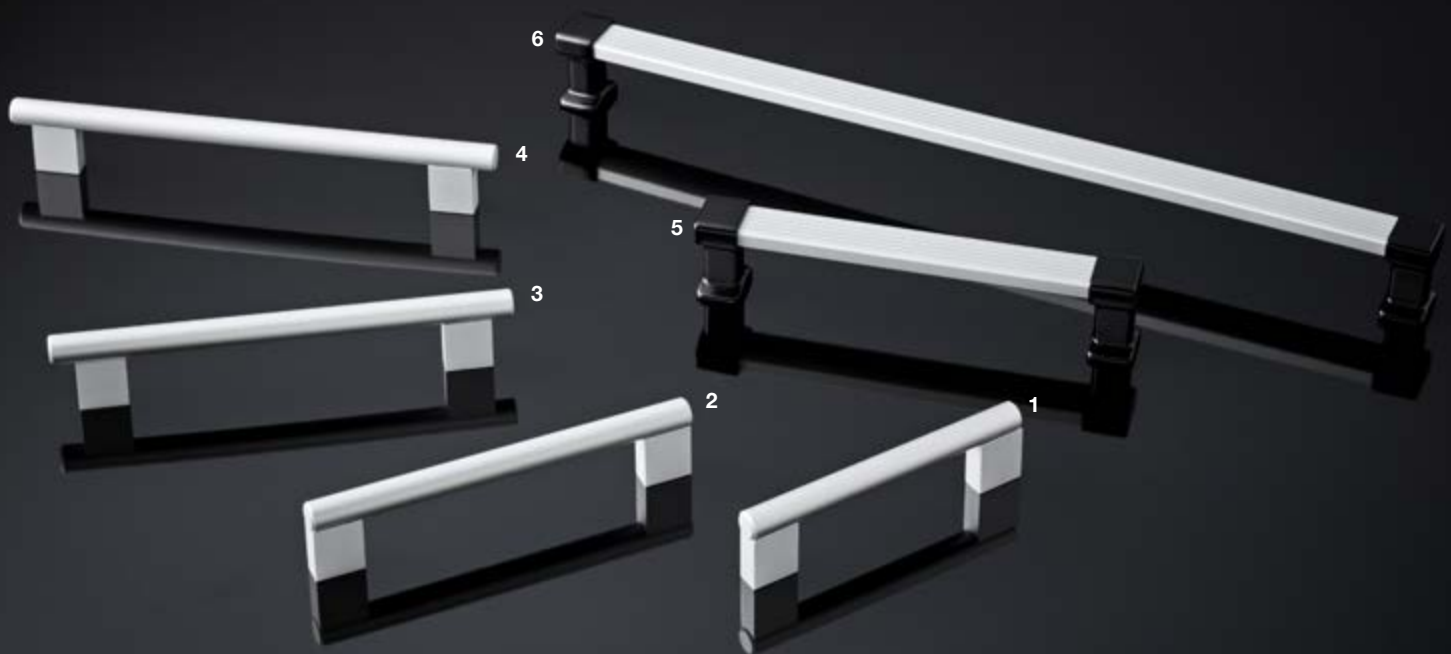
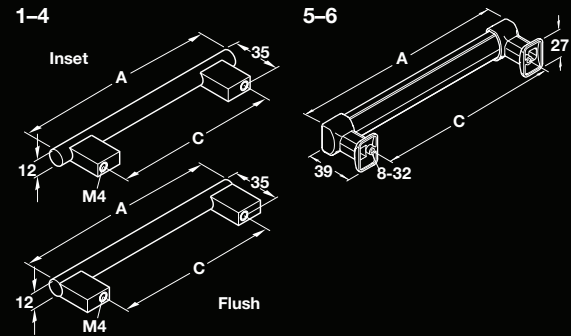

## Contemporary



**Material:** Stainless Steel Grade 304

	Finish	A	C	Item No.	SRP/pc.
1	matt	722	672	117.05.660	\$58.92
2	matt	946	896	117.05.670	\$78.24
3*	matt	–	–	117.05.680	\$80.33
4	matt	242	192	117.05.620	\$20.40
5	matt	530	480	117.05.650	\$53.36
6	matt	370	320	117.05.640	\$36.84
7	matt	274	224	117.05.630	\$27.92
8	matt	178	128	117.05.610	\$18.87
9	matt	146	96	117.05.600	\$12.87

**\*Note**

Supplied with 3 bases.

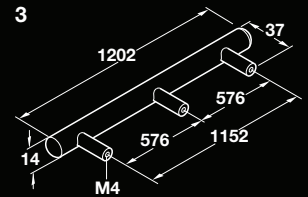
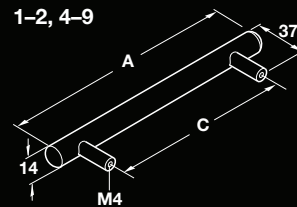

## Contemporary

**Material:** Stainless Steel Grade 304

	Finish	A	C	Item No.	SRP/pc.
1	matt	176	160	155.01.280	\$16.88
2	matt	—	—	134.88.610	\$14.31
3	matt	208	192	155.01.281	\$16.66
4	matt	304	288	155.01.283	\$20.62
5	matt	368	352	155.01.284	\$23.20
6	matt	464	448	155.01.285	\$26.82

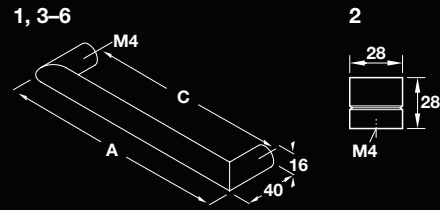

## Contemporary

**Material:** Stainless Steel/Zinc

	<b>Finish</b>	<b>A</b>	<b>C</b>	<b>Item No.</b>	<b>SRP/pc.</b>
1	matt nickel	234	224	104.74.064	\$34.82
2	matt nickel	330	320	104.74.065	\$42.76
3	matt nickel	490	480	104.74.066	\$55.68
4	matt nickel	106	96	104.74.061	\$24.44
5	matt nickel	202	192	104.74.063	\$32.28
6	matt nickel	138	128	104.74.062	\$23.85

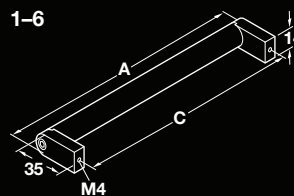



## Contemporary

Material: Steel

	Finish	A	C	Item No.	SRP/pc.
1	stainless steel look	–	–	131.33.700	\$3.58
2	stainless steel look	116	76 (3")	101.20.744	\$5.10
3	stainless steel look	136	96	155.00.780	\$5.20
4	stainless steel look	168	128	155.00.781	\$5.66
5	stainless steel look	226	156	155.00.783	\$6.91
6	stainless steel look	326	256	155.00.787	\$9.55
7	stainless steel look	376	306	155.00.789	\$12.32
8	stainless steel look	828	758	155.00.800	\$21.22
9	stainless steel look	526	456	155.00.795	\$15.02

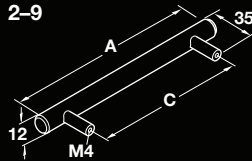
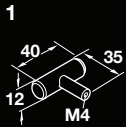

## Contemporary

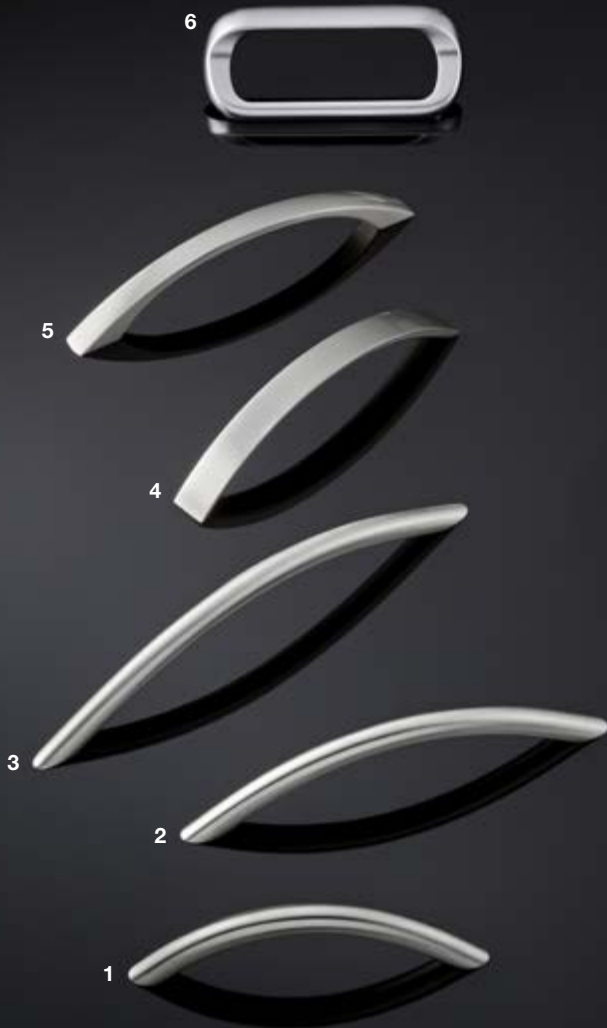

**Material:** Stainless Steel Grade 304

	Finish	A	B	C	Item No.	SRP/pc.
1	matt	115	30	96	117.64.616	\$18.06
2	matt	153	30	128	117.64.626	\$19.74
3	matt	190	32	160	117.64.636	\$25.82

**Material:** Zinc

	Finish	Item No.	SRP/pc.
4	stainless steel look	104.08.000	\$6.09
5	stainless steel look	102.47.953	\$13.24
6	matt chrome	151.33.203	\$10.45

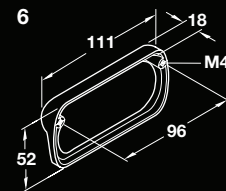
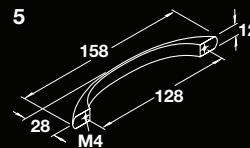
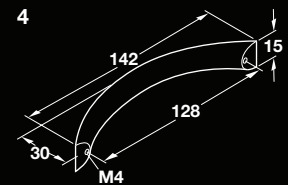
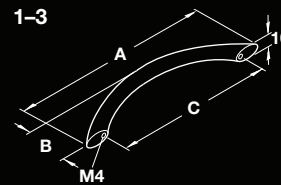

## Contemporary

**Material:** Zinc

	Finish	A	B	C	Item No.	SRP/pc.
1	stainless steel look	127	12	96	155.00.600	\$4.14
2	stainless steel look	160	13	128	155.00.601	\$5.35
3	stainless steel look	142	16	96	155.00.440	\$5.58
4	stainless steel look	183	17	128	155.00.441	\$5.65

**Material:** 1-4: Steel; 5-7: Zinc

	Finish	A	B	C	Item No.	SRP/pc.
1	matt black	112	30	96	155.00.880	\$3.23
2	matt black	148	30	128	155.00.881	\$5.03
3	matt black	-	-	-	134.44.310	\$2.59
4	matt chrome	-	-	-	134.45.430	\$2.92
5	matt nickel	-	-	-	134.45.600	\$3.15
6	polished chrome	-	-	-	134.45.200	\$2.67
7	dark oil-rubbed bronze	-	-	-	134.45.330	\$2.66

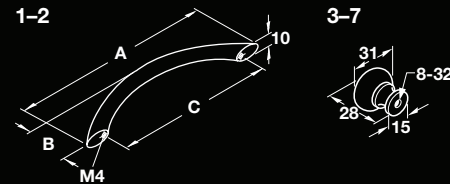
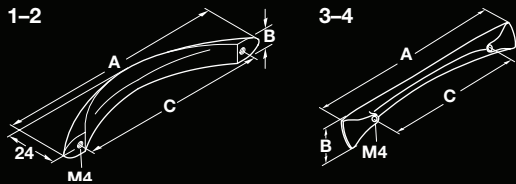

## Contemporary



**Material:** Steel

	Finish	A	C	Item No.	SRP/pc.
1	matt chrome	112	96	155.99.021	\$2.08
2	matt chrome	148	128	155.99.026	\$2.42
3	brushed nickel	112	96	155.99.022	\$2.00
4	brushed nickel	148	128	155.99.027	\$2.29
5	matt gold	112	96	155.99.032	\$2.19
6	matt gold	148	128	155.02.430	\$2.76

**Note**

For knobs with matching finishes, see page 16.  
Supplied with M4 mounting screws.

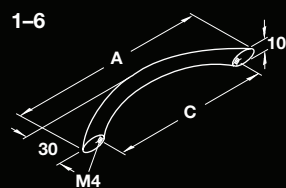

**Material:** Steel

	Finish	A	C	Item No.	SRP/pc.
1	oil-rubbed bronze	148	128	155.99.025	\$2.55
2	oil-rubbed bronze	112	96	155.99.020	\$2.19
3	polished chrome	148	128	155.99.023	\$2.52
4	polished chrome	112	96	155.99.018	\$2.19
5	matt black	148	128	155.99.024	\$2.22
6	matt black	112	96	155.99.019	\$1.96

**Note**

For knobs with matching finishes, see page 16.  
Supplied with M4 mounting screws.

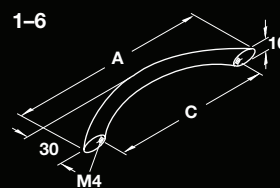

## Contemporary

**Material:** Steel

	Finish	A	C	Item No.	SRP/pc.
1	matt chrome	232	192	155.99.010	\$4.14
2	matt chrome	200	160	155.99.006	\$3.71
3	matt chrome	168	128	155.99.015	\$2.92
4	matt chrome	142	4"	155.00.696	\$3.05
5	matt chrome	136	96	155.99.001	\$2.45
6	matt chrome	129	88.9 (3.5")	155.00.697	\$2.87

**Note**

For knobs with matching finishes, see page 16.  
Supplied with M4 mounting screws.

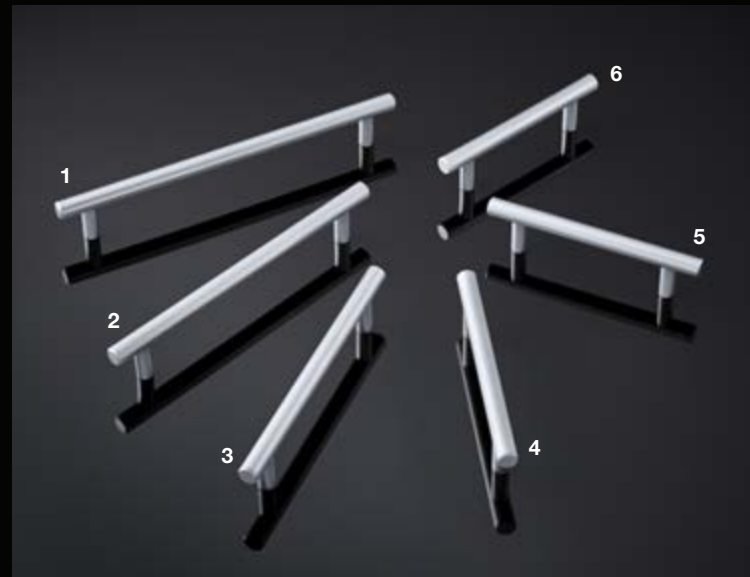
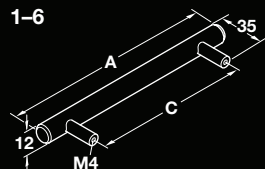

**Material:** Steel

	Finish	A	C	Item No.	SRP/pc.
1	matt gold	232	192	155.02.415	\$4.79
2	matt gold	200	160	155.02.414	\$4.27
3	matt gold	168	128	155.02.413	\$3.37
4	matt gold	136	96	155.02.411	\$3.10
5	matt gold	142	4"	155.02.412	\$3.14
6	matt gold	129	88.9 (3.5")	155.02.410	\$3.22

**Note**

For knobs with matching finishes, see page 16.  
Supplied with M4 mounting screws.

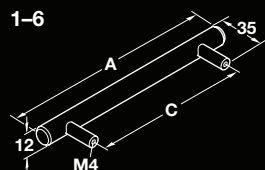

## Contemporary

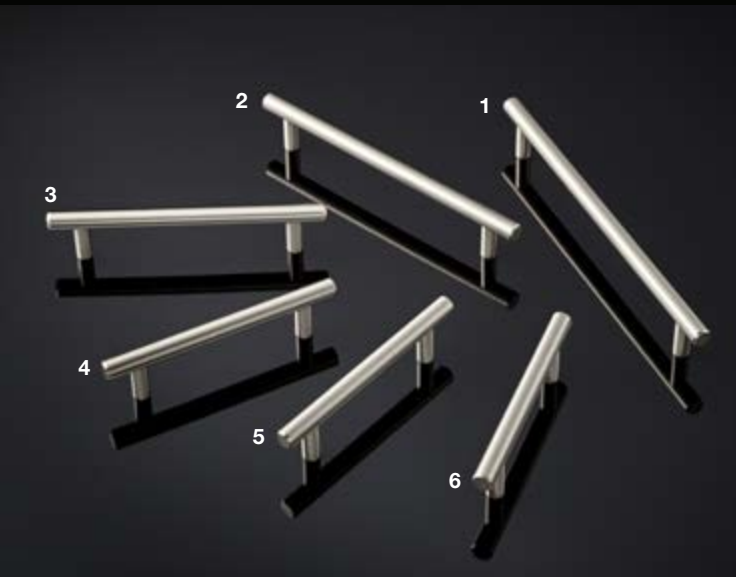

**Material:** Steel

	Finish	A	C	Item No.	SRP/pc.
1	brushed nickel	232	192	155.99.011	\$3.85
2	brushed nickel	200	160	155.99.007	\$3.42
3	brushed nickel	168	128	155.99.016	\$2.99
4	brushed nickel	136	96	155.99.000	\$3.06
5	brushed nickel	142	4"	155.00.801	\$2.77
6	brushed nickel	129	88.9 (3.5")	155.00.721	\$2.63

**Note**

For knobs with matching finishes, see page 16.  
Supplied with M4 mounting screws.

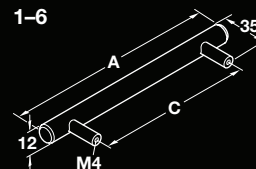

**Material:** Steel

	Finish	A	C	Item No.	SRP/pc.
1	matt black	232	192	155.99.012	\$3.63
2	matt black	200	160	155.99.008	\$3.26
3	matt black	168	128	155.99.017	\$2.89
4	matt black	136	96	155.99.002	\$2.57
5	matt black	142	4"	155.01.669	\$2.74
6	matt black	129	88.9 (3.5")	155.01.668	\$2.59

**Note**

For knobs with matching finishes, see page 16.  
Supplied with M4 mounting screws.

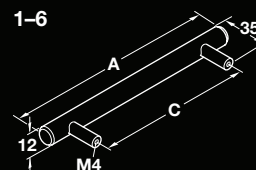

## Contemporary

**Material:** Steel

	Finish	A	C	Item No.	SRP/pc.
1	oil-rubbed bronze	232	192	155.00.765	\$5.60
2	oil-rubbed bronze	200	160	155.00.764	\$5.10
3	oil-rubbed bronze	168	128	155.99.013	\$3.48
4	oil-rubbed bronze	142	4"	155.00.766	\$3.93
5	oil-rubbed bronze	136	96	155.99.004	\$3.43
6	oil-rubbed bronze	129	88.9 (3.5")	155.00.751	\$3.69

**Note**

For knobs with matching finishes, see page 16.  
Supplied with M4 mounting screws.

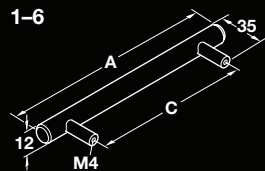

**Material:** Steel

	Finish	A	C	Item No.	SRP/pc.
1	polished chrome	168	128	155.99.014	\$2.81
2	polished chrome	200	160	155.99.005	\$3.14
3	polished chrome	232	192	155.99.009	\$3.48
4	polished chrome	142	4"	155.02.421	\$2.45
5	polished chrome	129	88.9 (3.5")	155.02.420	\$2.29
6	polished chrome	136	96	155.99.003	\$2.91

**Note**

For knobs with matching finishes, see page 16.  
Supplied with M4 mounting screws.

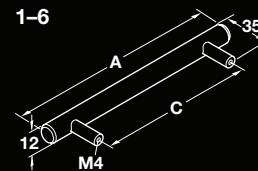

## Contemporary

**Material:** Steel

	<b>Finish</b>	<b>A</b>	<b>C</b>	<b>Item No.</b>	<b>SRP/pc.</b>
1	matt nickel	97	3.5"	116.07.611	\$1.89
2	matt nickel	104	96	116.07.621	\$1.93
3	matt nickel	110	4"	116.07.632	\$1.99
4	polished chrome	97	3.5"	116.07.219	\$1.86
5	polished chrome	104	96	116.07.228	\$1.90
6	polished chrome	110	4"	116.07.238	\$1.96
7	satin chrome	97	3.5"	116.07.419	\$1.86
8	satin chrome	104	96	116.07.429	\$1.90
9	satin chrome	110	4"	116.07.438	\$1.96
10	matt gold	97	3.5"	116.07.221	\$1.92
11	matt gold	104	96	116.07.229	\$2.27
12	matt gold	110	4"	116.07.240	\$2.35

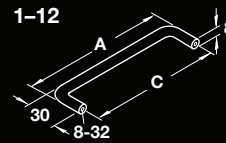

**Note**

For knobs with matching finishes, see page 16.





## Contemporary

**Material:** Steel

	<b>Finish</b>	<b>A</b>	<b>C</b>	<b>Item No.</b>	<b>SRP/pc.</b>
1	brushed nickel	104	96	116.07.628	\$1.78
2	brushed nickel	110	4"	116.07.639	\$2.06
3	brushed nickel	97	3.5"	116.07.619	\$1.95
4	dark oil-rubbed bronze	104	96	116.07.321	\$1.84
5	dark oil-rubbed bronze	110	4"	116.07.339	\$1.87
6	dark oil-rubbed bronze	97	3.5"	116.07.319	\$1.74

**Note**

For knobs with matching finishes, see page 16.

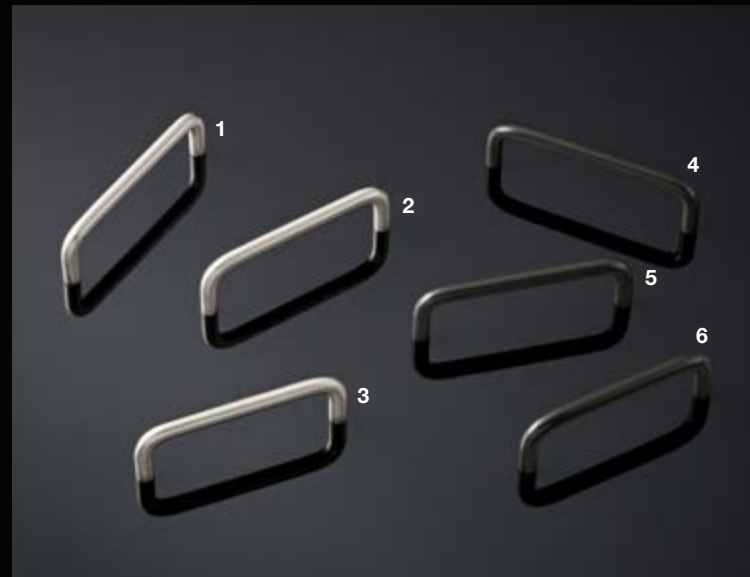
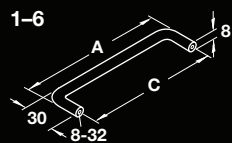

**Material:** Steel

	<b>Finish</b>	<b>A</b>	<b>C</b>	<b>Item No.</b>	<b>SRP/pc.</b>
1	matt chrome	97	3.5"	116.07.413	\$1.89
2	matt chrome	110	4"	116.07.439	\$1.78
3	matt chrome	104	96	116.07.421	\$1.93
4	matt black	97	3.5"	116.07.318	\$1.74
5	matt black	110	4"	116.07.338	\$1.87
6	matt black	104	96	116.07.329	\$1.84

**Note**

For knobs with matching finishes, see page 16.

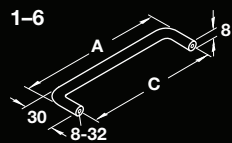

## Traditional NEW

**Material:** Zinc

	<b>Finish</b>	<b>Item No.</b>	<b>SRP/pc.</b>
1	matt nickel	111.95.364	\$8.14
2	black	111.95.361	\$8.14
3	matt aluminum	111.95.362	\$8.14
4	slate/graphite	111.95.365	\$9.61
5	matt gold	111.95.363	\$9.61
6	polished chrome	111.95.360	\$7.48

1-6

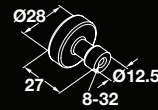

**Note**

Tag finishes match and are ideal for use with Synergy, Synergy Elite, Engage and Signature closet accessories. See the Closet and Home Solutions catalog. Supplied with 1" mounting screws.



## Traditional NEW

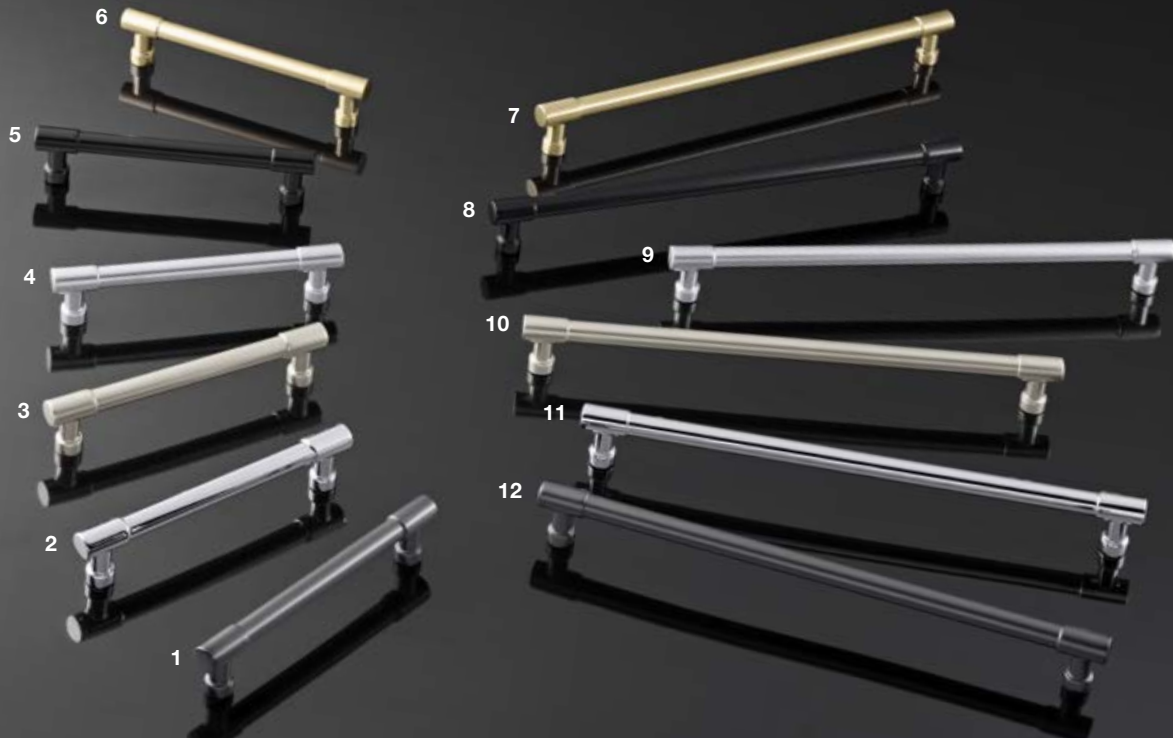

**Material:** Zinc

	<b>Finish</b>	<b>Item No.</b>	<b>SRP/pc.</b>
1	slate/graphite	111.95.335	\$23.06
2	polished chrome	111.95.330	\$17.53
3	matt nickel	111.95.333	\$19.13
4	matt aluminum	111.95.331	\$19.13
5	black	111.95.334	\$19.13
6	matt gold	111.95.332	\$23.06
7	matt gold	111.95.342	\$49.14
8	black	111.95.344	\$41.62
9	matt aluminum	111.95.341	\$41.62
10	matt nickel	111.95.343	\$41.62
11	polished chrome	111.95.340	\$37.84
12	slate/graphite	111.95.345	\$49.14

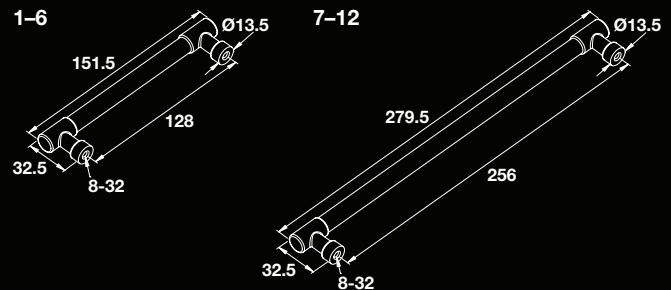

**Note**

Tag finishes match and are ideal for use with Synergy, Synergy Elite, Engage and Signature closet accessories. See the Closet and Home Solutions catalog. Supplied with 1" mounting screws.

## Traditional NEW

**Material:** Zinc

	<b>Finish</b>	<b>Item No.</b>	<b>SRP/pc.</b>
1	black	111.95.354	\$57.20
2	slate/graphite	111.95.355	\$67.56
3	matt gold	111.95.352	\$67.56
4	matt nickel	111.95.353	\$57.20
5	matt aluminum	111.95.351	\$57.20
6	polished chrome	111.95.350	\$51.96

**Note**

Tag finishes match and are ideal for use with Synergy, Synergy Elite, Engage and Signature closet accessories. See the Closet and Home Solutions catalog. Supplied with 1" mounting screws.

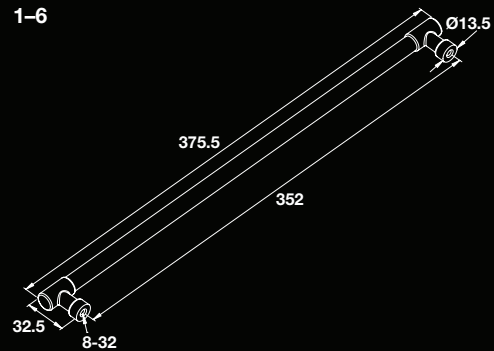

## Minimalist



**Material:** Aluminum

	<b>Finish</b>	<b>Length</b>	<b>Item No.</b>	<b>SRP/pc.</b>
1	matt aluminum	2500 mm	126.14.901	\$65.08
2	matt aluminum	2500 mm	126.15.900	\$82.82
3	matt aluminum	2500 mm	126.22.909	\$67.84
4	satin aluminum	2500 mm	126.22.036	\$67.44
5	matt aluminum	2500 mm	792.01.060	\$75.30

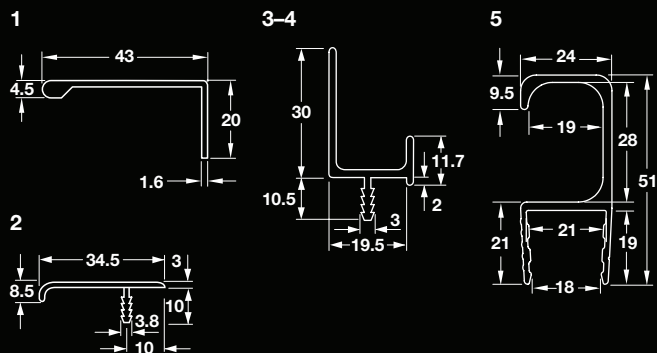

## Minimalist

**Material:** Aluminum

	<b>Finish</b>	<b>Length</b>	<b>Item No.</b>	<b>SRP/pc.</b>
1	matt black	2500 mm	126.27.310	\$106.46
2	matt aluminum	2500 mm	155.01.150	\$110.12
3	satin aluminum	2500 mm	126.27.036	\$107.52
4	black	2500 mm	126.27.306	\$96.40

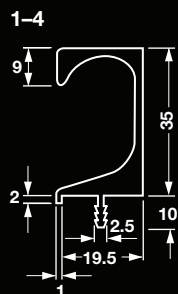

## Minimalist

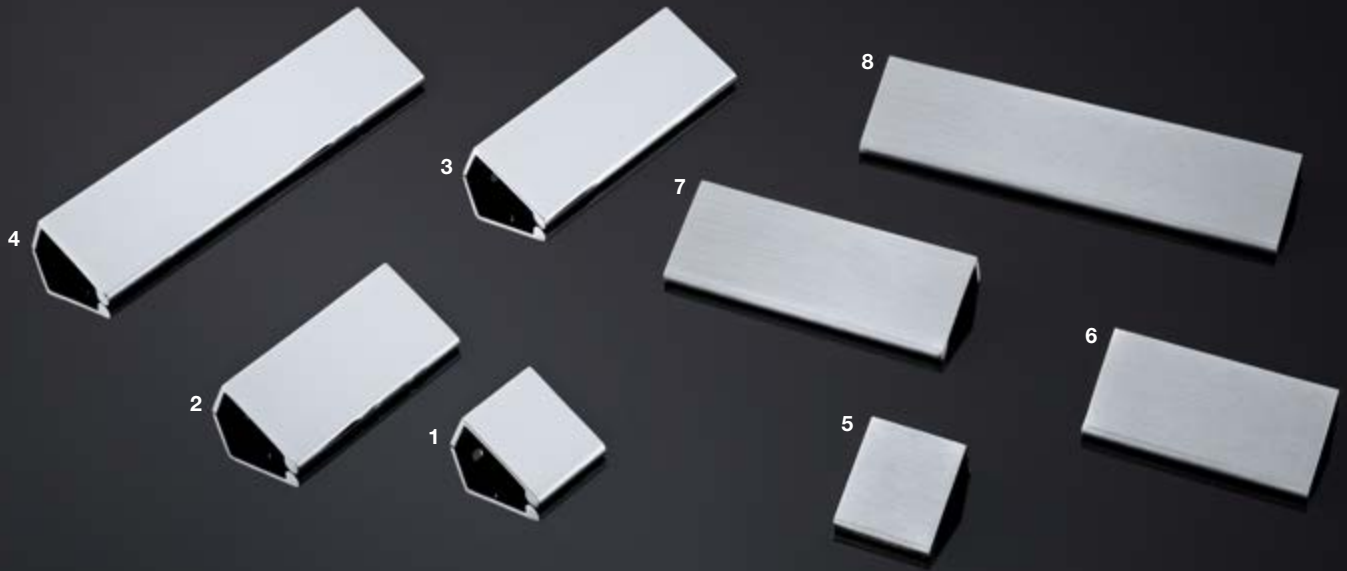

**Material:** Brass

	<b>Finish</b>	<b>A</b>	<b>C</b>	<b>Item No.</b>	<b>SRP/pc.</b>
1	polished chrome	32 (1.25")	16	103.20.230	\$10.80
2	polished chrome	76 (3")	51 (2")	103.20.231	\$20.46
3	polished chrome	102 (4")	76 (3")	103.20.242	\$21.50
4	polished chrome	152 (6")	127 (5")	103.20.244	\$24.90
5	satin chrome	32 (1.25")	16	103.20.430	\$10.17
6	satin chrome	76 (3")	51 (2")	103.20.431	\$21.46
7	satin chrome	102 (4")	76 (3")	103.20.442	\$20.42
8	satin chrome	152 (6")	127 (5")	103.20.444	\$23.36

**Note**

Supplied with mounting screws.

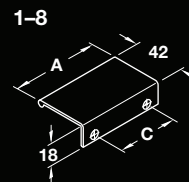

# Minimalist



**Material:** Aluminum

	<b>Finish</b>	<b>Item No.</b>	<b>SRP/pc.</b>
1	dark oil-rubbed bronze	124.02.104	\$17.78
2	matt aluminum	124.02.984	\$17.06
3	polished black	124.02.344	\$20.52
4	silver anodized	124.02.974	\$18.49
5	brushed brass	124.02.502	\$22.90
6	satin aluminum	124.02.444	\$19.00
7	polished chrome	124.02.244	\$20.36

**Note**

Supplied with mounting screws.

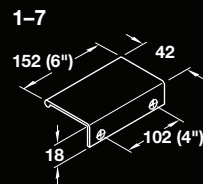



## Minimalist

**Material:** Aluminum

	<b>Finish</b>	<b>A</b>	<b>C</b>	<b>Item No.</b>	<b>SRP/pc.</b>
1	silver anodized	40	25	124.02.910	\$8.74
2	silver anodized	70	50	124.02.920	\$12.30
3	polished chrome	70	50	124.02.220	\$10.75
4	polished chrome	40	25	124.02.210	\$8.69
5	matt aluminum	40	25	124.02.911	\$9.80
6	matt aluminum	70	50	124.02.921	\$12.03
7	polished black	40	25	124.02.310	\$8.63
8	polished black	70	50	124.02.320	\$13.81

**Note**

Supplied with mounting screws.

1-8

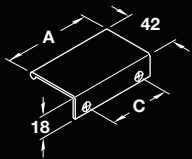

## Minimalist

**Material:** Aluminum

	<b>Finish</b>	<b>A</b>	<b>C</b>	<b>Item No.</b>	<b>SRP/pc.</b>
1	dark oil-rubbed bronze	40	25	124.02.330	\$7.11
2	dark oil-rubbed bronze	70	50	124.02.332	\$10.70
3	satin aluminum	40	25	124.02.430	\$8.97
4	satin aluminum	70	50	124.02.432	\$16.40
5	brushed brass	40	25	124.02.500	\$7.52
6	brushed brass	70	50	124.02.501	\$10.13

**Note**

Supplied with mounting screws.

1-6

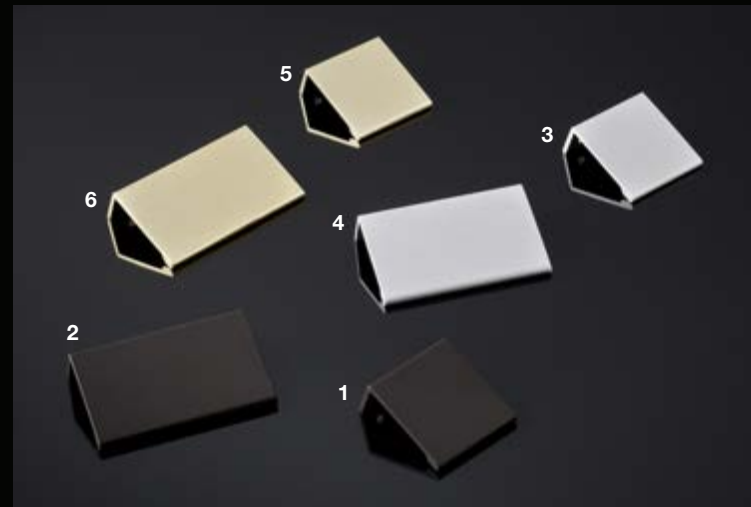
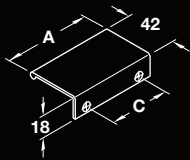

## TAG Minimalist

**Material:** Aluminum

	<b>Finish</b>	<b>Length</b>	<b>Item No.</b>	<b>SRP/pc.</b>
1	slate/graphite	3"	111.95.220	\$11.87
2	black	3"	111.95.320	\$9.36
3	matt aluminum	3"	111.95.190	\$8.39
4	polished chrome	3"	111.95.230	\$12.01
5	matt gold	3"	111.95.192	\$11.45

**Note**

TAG finishes match and are ideal for use with Synergy, Synergy Elite, Engage and Signature closet accessories. See the Closet and Home Solutions catalog. Supplied with mounting screws.

1-5

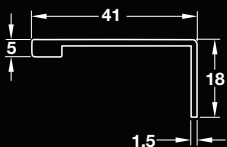

## TAG Minimalist

**Material:** Aluminum

	<b>Finish</b>	<b>Length</b>	<b>Item No.</b>	<b>SRP/pc.</b>
1	slate/graphite	9"	111.95.240	\$21.46
2	slate/graphite	18.5"	111.95.221	\$34.02
3	black	18.5"	111.95.322	\$27.36
4	polished chrome	18.5"	111.95.231	\$33.80
5	black	9"	111.95.321	\$17.56

**Note**

TAG finishes match and are ideal for use with Synergy, Synergy Elite, Engage and Signature closet accessories. See the Closet and Home Solutions catalog. Supplied with mounting screws.

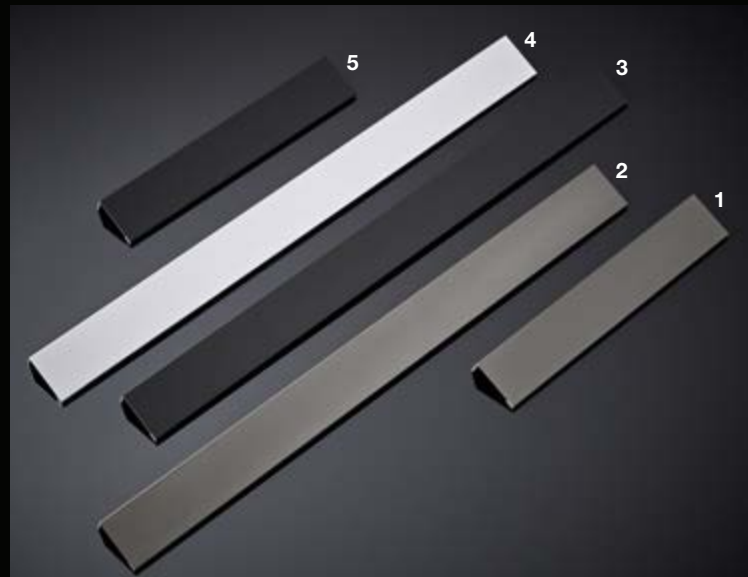

**1-5**

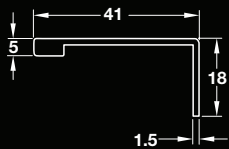

**Material:** Aluminum

	<b>Finish</b>	<b>Length</b>	<b>Item No.</b>	<b>SRP/pc.</b>
1	matt aluminum	9"	111.95.242	\$15.86
2	matt aluminum	18.5"	111.95.195	\$24.88
3	matt gold	18.5"	111.95.197	\$32.78
4	matt gold	9"	111.95.244	\$20.70
5	polished chrome	9"	111.95.241	\$23.18

**Note**

TAG finishes match and are ideal for use with Synergy, Synergy Elite, Engage and Signature closet accessories. See the Closet and Home Solutions catalog. Supplied with mounting screws.



**1-5**

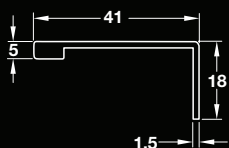

# TAG Minimalist



**Material:** Aluminum

	<b>Finish</b>	<b>Length</b>	<b>Item No.</b>	<b>SRP/pc.</b>
1	polished chrome	24.5"	111.95.232	\$43.38
2	black	24.5"	111.95.323	\$35.84
3	matt aluminum	24.5"	111.95.200	\$32.22
4	slate/graphite	24.5"	111.95.222	\$44.82
5	matt gold	24.5"	111.95.202	\$43.26

**Note**

TAG finishes match and are ideal for use with Synergy, Synergy Elite, Engage and Signature closet accessories. See the Closet and Home Solutions catalog. Supplied with mounting screws.

1-5

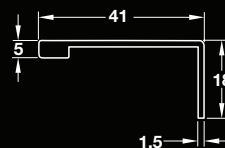

## TAG Minimalist

**Material:** Aluminum

	<b>Finish</b>	<b>Length</b>	<b>Item No.</b>	<b>SRP/pc.</b>
1	matt gold	30.5"	111.95.207	\$49.98
2	black	30.5"	111.95.324	\$41.24
3	polished chrome	30.5"	111.95.233	\$49.92
4	slate/graphite	30.5"	111.95.223	\$51.80
5	matt aluminum	30.5"	111.95.205	\$37.34

**Note**

TAG finishes match and are ideal for use with Synergy, Synergy Elite, Engage and Signature closet accessories. See the Closet and Home Solutions catalog. Supplied with mounting screws.

**1-5**

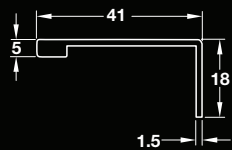

# TAG Minimalist



**Material:** Aluminum

	<b>Finish</b>	<b>Length</b>	<b>Item No.</b>	<b>SRP/pc.</b>
1	matt gold	36.5"	111.95.212	\$59.96
2	slate/graphite	36.5"	111.95.224	\$54.96
3	polished chrome	36.5"	111.95.234	\$50.28
4	black	36.5"	111.95.325	\$49.74
5	matt aluminum	36.5"	111.95.210	\$44.80

**Note**

TAG finishes match and are ideal for use with Synergy, Synergy Elite, Engage and Signature closet accessories. See the Closet and Home Solutions catalog. Supplied with mounting screws.

**1-5**

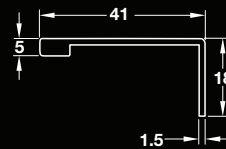

# TAG Minimalist



**Material:** Aluminum; Finish: matt nickel

	Length	Item No.	SRP/pc.
1	3"	111.95.250	\$10.04
2	9"	111.95.251	\$17.16
3	18.5"	111.95.252	\$27.36
4	36.5"	111.95.255	\$49.74
5	30.5"	111.95.254	\$41.24
6	24.5"	111.95.253	\$35.84

**Note**

TAG finishes match and are ideal for use with Synergy, Synergy Elite, Engage and Signature closet accessories. See the Closet and Home Solutions catalog. Supplied with mounting screws.

1-6

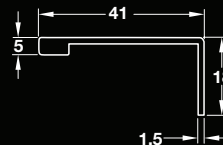

## Architectural

**Material:** Center/Ends: Stainless Steel/Zinc

	<b>Finish</b>	<b>A</b>	<b>C</b>	<b>Item No.</b>	<b>SRP/pc.</b>
1	matt/stainless steel look	116	96	155.00.960	\$27.04
2	matt/stainless steel look	148	128	155.00.961	\$26.88
3	matt/stainless steel look	212	192	155.00.962	\$30.10
4	matt/stainless steel look	242	224	155.00.963	\$39.70
5	matt/stainless steel look	692	672	155.00.966	\$81.52
6	matt/stainless steel look	500	480	155.00.965	\$62.66
7	matt/stainless steel look	340	320	155.00.964	\$39.52

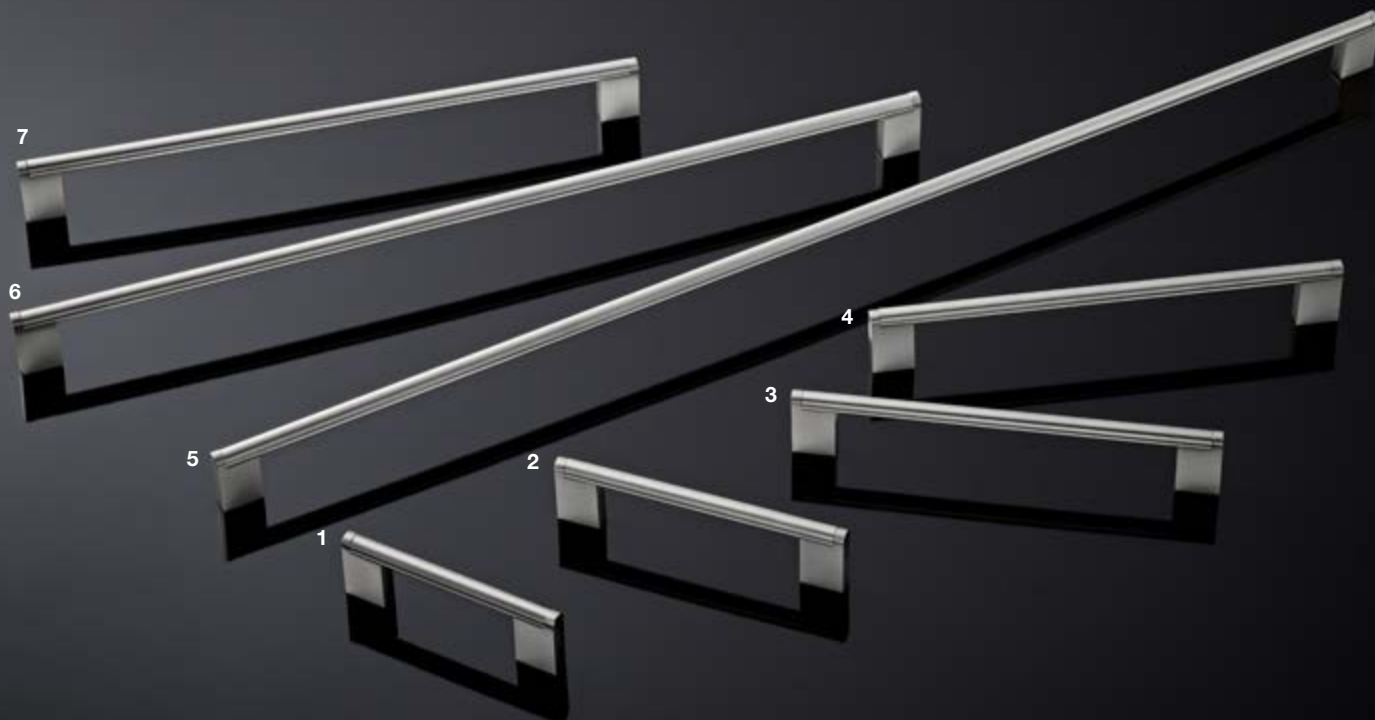
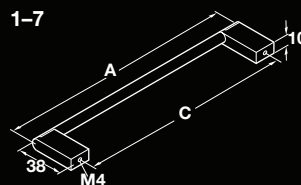



## Architectural

**Material:** Center/Ends: Stainless Steel/Zinc

	Finish	A	C	Item No.	SRP/pc.
1	matt/stainless steel look	916	896	115.70.008	\$99.38
2	matt/stainless steel look	1428	1408	115.70.010	\$137.30
3	matt/stainless steel look	1172	1152	115.70.009	\$114.54

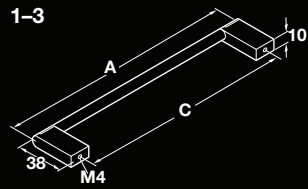

## Architectural



**Material:** Steel; **Finish:** matt black

	A	B	C	D	T	Item No.	SRP/pc.
1	75	32	69	26	9	151.00.311	\$5.86
2	100	39	96	32	11	151.00.320	\$6.98

**Material:** Brass; **Finish:** polished nickel

	A	B	C	D	T	Item No.	SRP/pc.
3	75	32	69	26	9	155.01.545	\$8.92
4	100	39	96	32	11	155.01.546	\$15.00

**Material:** Zinc/Steel

	Finish	Item No.	SRP/pc.
5	matt nickel/back:black	151.09.609	\$14.55

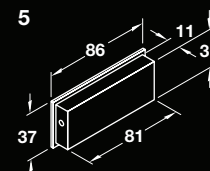
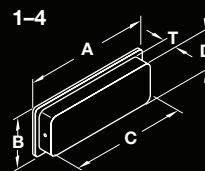

## Architectural

**Material:** Zinc

	<b>Finish</b>	<b>Item No.</b>	<b>SRP/pc.</b>
1	matt chrome	151.35.262	\$24.88
2	matt nickel	151.35.665	\$25.64
3	matt chrome	151.50.215	\$26.94
4	matt nickel	155.00.540	\$74.80
5	polished chrome	155.00.545	\$58.16
6	matt chrome	151.35.208	\$14.81

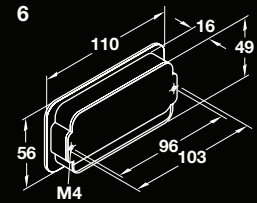
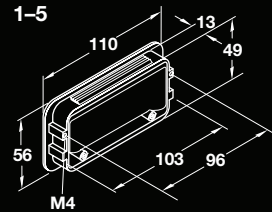

## Architectural

**Material:** Stainless Steel Grade 304

	<b>Finish</b>	<b>A</b>	<b>C</b>	<b>Item No.</b>	<b>SRP/pc.</b>
1	matt	106	96	115.61.601	\$14.38
2	matt	138	128	115.61.602	\$17.76
3	matt	170	160	115.61.603	\$22.40
4	matt	202	192	115.61.604	\$25.36
5	matt	298	288	115.61.607	\$31.42

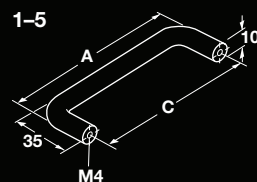

## Architectural

**Material:** Stainless Steel Grade 304

	<b>Finish</b>	<b>A</b>	<b>C</b>	<b>Item No.</b>	<b>SRP/pc.</b>
1	matt	143	128	100.45.051	\$18.32
2	matt	243	228	100.45.055	\$20.78
3	matt	650	635	100.45.059	\$26.88
4	matt	345	330	100.45.058	\$53.28

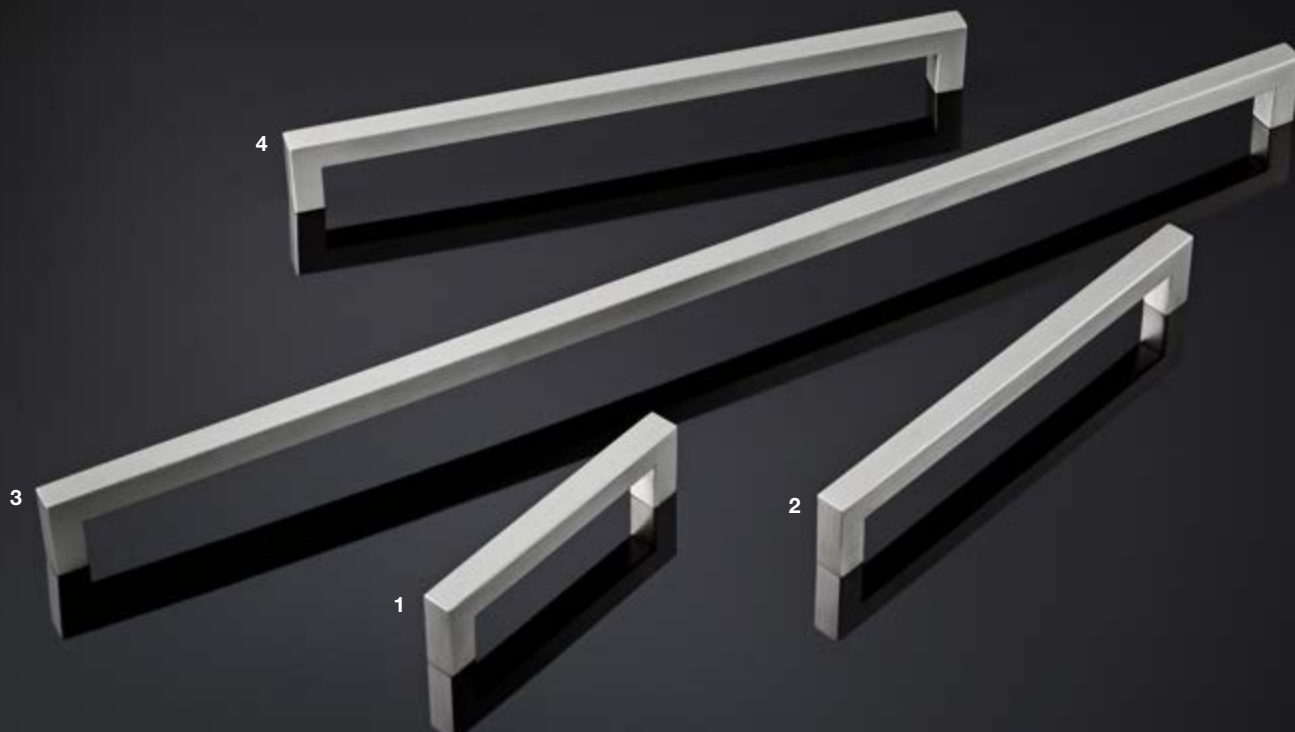
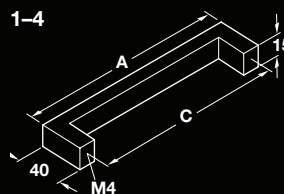

## Screws

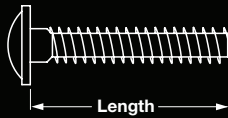

### M4, with Combi Cross/Slot Drive

**Material:** Steel; Finish: zinc-plated

#### Length

Length	Item No.	SRP/pkg.
M4 x 10 (13/32")	022.35.109	\$9.58
M4 x 12 (1/2")	022.35.127	\$10.06
M4 x 15 (5/8")	022.35.154	\$10.49
M4 x 18 (1 1/16")	022.35.181	\$11.26
M4 x 20 (13/16")	022.35.207	\$11.42
M4 x 22 (7/8")	022.35.225	\$11.88
M4 x 23 (15/16")	022.35.234	\$12.38
M4 x 25 (1")	022.35.252	\$13.80
M4 x 28 (1 1/8")	022.35.289	\$13.87
M4 x 30 (1 3/16")	022.35.305	\$14.30
M4 x 35 (1 3/8")	022.35.350	\$15.41
M4 x 38 (1 1/2")	022.35.387	\$16.48
M4 x 40 (1 9/16")	022.35.403	\$17.74
M4 x 45 (1 3/4")	022.35.458	\$20.93
M4 x 55 (2 5/32")	022.35.550	\$17.40
M4 x 70 (2 3/4")	022.35.700	\$41.09
M4 x 75 (3")	022.35.750	\$29.88

### M4, with Combi Cross/Slot Drive

**Material:** Steel; Finish: nickel-plated

#### Length

Length	Item No.	SRP/pkg.
M4 x 15 (5/8")	022.34.157	\$12.48
M4 x 25 (1")	022.34.255	\$14.90

#### Supplied with

100 pcs. per package

## Screws

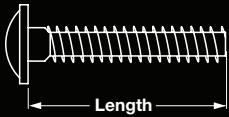

### 8-32, with Combi Cross/Slot Drive

**Material:** Steel; Finish: yellow zinc

#### Length

8-32 x 10 (13/32")
8-32 x 15 (5/8")
8-32 x 20 (13/16")
8-32 x 25 (1")
8-32 x 25 (1")
8-32 x 38 (1 1/2")
8-32 x 45 (1 3/4")

Finish: zinc-plated

#### Length

8-32 x 22 (7/8")
8-32 x 32 (1 1/4")
8-32 x 35 (1 3/8")
8-32 x 42 (1 11/16")
8-32 x 48 (1 7/8")
8-32 x 51 (2")

#### Supplied with

100 pcs. per package

Item No.	SRP/pkg.	Bulk Item No.	Qty/pkg.	SRP/pkg.
—	—	022.25.100	1,000	\$63.80
—	—	022.25.150	1,000	\$65.80
—	—	022.25.200	1,000	\$79.00
022.24.256	\$11.06	022.25.256	500	\$43.45
—	—	022.25.258	5,000	\$354.00
022.24.381	\$16.80	022.25.381	500	\$58.20
022.24.452	\$21.07	022.25.452	500	\$72.50

Item No.	SRP/pkg.	Bulk Item No.	Qty/pkg.	SRP/pkg.
022.24.229	\$10.44	022.25.229	1,000	\$124.30
022.24.327	\$13.66	022.25.327	500	\$63.35
022.25.350	\$15.26	—	—	—
022.24.410	\$18.00	022.25.410	500	\$80.05
022.24.470	\$19.13	—	—	—
022.24.500	\$18.74	022.25.500	500	\$69.25

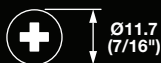
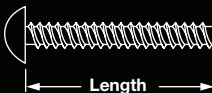

### M6, with #2 Phillips Drive

**Material:** Steel; Finish: zinc-plated

#### Length

M6 x 20 (13/16")
M6 x 25 (1")
M6 x 30 (1 3/16")
M6 x 40 (1 9/16")
M6 x 45 (1 3/4")
M6 x 50 (2")

#### Item No.

020.43.271
020.43.272
020.43.273
020.43.275
020.43.276
020.43.277

#### SRP/pkg.

\$11.85
\$30.48
\$14.74
\$20.04
\$23.33
\$24.55

#### Supplied with

50 pcs. per package

## Screws

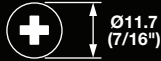
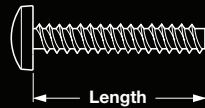

### 1/4-20, with #2 Phillips Drive

**Material:** Steel; Finish: zinc-plated

**Length**

- 1/4-20 x 3/4"
- 1/4-20 x 1"
- 1/4-20 x 1 1/4"
- 1/4-20 x 1 1/2"
- 1/4-20 x 1 3/4"
- 1/4-20 x 2"
- 1/4-20 x 2 1/2"
- 1/4-20 x 3"

**Item No.**

- 020.42.271
- 020.42.272
- 020.42.273
- 020.42.275
- 020.42.276
- 020.42.277
- 020.42.280
- 020.42.282

**SRP/pkg.**

- \$12.19
- \$10.50
- \$14.74
- \$16.44
- \$20.88
- \$21.94
- \$30.54
- \$32.73

**Supplied with**

50 pcs. per package

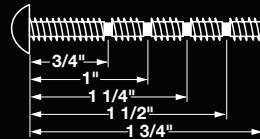

### 8-32, cut-off

**Material:** Steel; Finish: yellow chromate

**Length**

- 8-32 x 19 – 45 (3/4 x 1 3/4")

**Item No.**

- 022.24.881

**SRP/pkg.**

- \$21.84

### M4, cut-off

**Material:** Steel; Finish: zinc-plated

**Length**

- M4 x 19 – 45 (3/4 x 1 3/4")

**Item No.**

- 022.35.887

**SRP/pkg.**

- \$20.62

**Supplied with**

100 pcs. per package



### Round Head Metal Brads

**Material:** Steel; Finish: nickel-plated

**Length**

- 1.6 x 15

**Item No.**

- 076.40.299

**SRP/pkg.**

- \$105.43

**Supplied with**

2,000 pcs. per package



## Index

Item No.	Page No.	Item No.	Page No.	Item No.	Page No.	Item No.	Page No.	Item No.	Page No.
020.42.271	53	022.35.350	51	110.18.357	15	111.95.170	3	111.95.272	4
020.42.272	53	022.35.387	51	111.04.114	1	111.95.171	3	111.95.273	4
020.42.273	53	022.35.403	51	111.04.115	1	111.95.172	3	111.95.275	4
020.42.275	53	022.35.458	51	111.04.116	1	111.95.174	3	111.95.280	4
020.42.276	53	022.35.550	51	111.04.117	1	111.95.175	3	111.95.281	4
020.42.277	53	022.35.700	51	111.95.000	13	111.95.180	3	111.95.282	4
020.42.280	53	022.35.750	51	111.95.001	13	111.95.181	3	111.95.283	4
020.42.282	53	022.35.887	53	111.95.003	13	111.95.182	3	111.95.285	4
020.43.271	52	076.40.299	53	111.95.004	13	111.95.184	3	111.95.290	10
020.43.272	52	100.45.051	50	111.95.005	13	111.95.185	3	111.95.291	10
020.43.273	52	100.45.055	50	111.95.063	18	111.95.190	39	111.95.292	10
020.43.275	52	100.45.058	50	111.95.069	18	111.95.192	39	111.95.294	10
020.43.276	52	100.45.059	50	111.95.100	11	111.95.195	40	111.95.295	10
020.43.277	52	101.20.744	22	111.95.101	11	111.95.197	40	111.95.300	2
022.24.229	52	102.47.953	23	111.95.102	11	111.95.200	41	111.95.301	12
022.24.256	52	103.20.230	36	111.95.104	11	111.95.202	41	111.95.302	3
022.24.327	52	103.20.231	36	111.95.105	11	111.95.205	42	111.95.303	13
022.24.381	52	103.20.242	36	111.95.110	11	111.95.207	42	111.95.304	11
022.24.410	52	103.20.244	36	111.95.111	11	111.95.210	43	111.95.305	4
022.24.452	52	103.20.430	36	111.95.112	11	111.95.212	43	111.95.306	4
022.24.470	52	103.20.431	36	111.95.114	11	111.95.220	39	111.95.307	4
022.24.500	52	103.20.442	36	111.95.115	11	111.95.221	40	111.95.308	2
022.24.881	53	103.20.444	36	111.95.120	13	111.95.222	41	111.95.309	12
022.25.100	52	104.08.000	23	111.95.121	13	111.95.223	42	111.95.310	3
022.25.150	52	104.74.061	21	111.95.122	13	111.95.224	43	111.95.311	11
022.25.200	52	104.74.062	21	111.95.124	13	111.95.230	39	111.95.312	10
022.25.229	52	104.74.063	21	111.95.125	13	111.95.231	40	111.95.313	13
022.25.256	52	104.74.064	21	111.95.130	2	111.95.232	41	111.95.320	39
022.25.258	52	104.74.065	21	111.95.131	2	111.95.233	42	111.95.321	40
022.25.327	52	104.74.066	21	111.95.132	2	111.95.234	43	111.95.322	40
022.25.350	52	106.61.123	6	111.95.134	2	111.95.240	40	111.95.323	41
022.25.381	52	106.61.124	6	111.95.135	2	111.95.241	40	111.95.324	42
022.25.410	52	106.61.223	6	111.95.140	2	111.95.242	40	111.95.325	43
022.25.452	52	106.61.224	6	111.95.141	2	111.95.244	40	111.95.330	32
022.25.500	52	107.18.352	14	111.95.142	2	111.95.250	44	111.95.331	32
022.34.157	51	107.18.353	14	111.95.144	2	111.95.251	44	111.95.332	32
022.34.255	51	107.18.358	14	111.95.145	2	111.95.252	44	111.95.333	32
022.35.109	51	107.18.612	14	111.95.150	12	111.95.253	44	111.95.334	32
022.35.127	51	107.18.613	14	111.95.151	12	111.95.254	44	111.95.335	32
022.35.154	51	107.18.618	14	111.95.152	12	111.95.255	44	111.95.340	32
022.35.181	51	109.86.002	5	111.95.154	12	111.95.260	4	111.95.341	32
022.35.207	51	109.86.027	5	111.95.155	12	111.95.261	4	111.95.342	32
022.35.225	51	109.86.125	5	111.95.160	12	111.95.262	4	111.95.343	32
022.35.234	51	109.86.127	5	111.95.161	12	111.95.263	4	111.95.344	32
022.35.252	51	109.86.202	5	111.95.162	12	111.95.265	4	111.95.345	32
022.35.289	51	109.86.227	5	111.95.164	12	111.95.270	4	111.95.350	33
022.35.305	51	110.18.057	15	111.95.165	12	111.95.271	4	111.95.351	33

## Index

Item No.	Page No.	Item No.	Page No.	Item No.	Page No.	Item No.	Page No.	Item No.	Page No.
111.95.352	33	117.05.650	19	134.06.641	16	155.00.766	28	155.02.411	26
111.95.353	33	117.05.660	19	134.44.310	24	155.00.780	22	155.02.412	26
111.95.354	33	117.05.670	19	134.45.030	14	155.00.781	22	155.02.413	26
111.95.355	33	117.05.680	19	134.45.200	24	155.00.783	22	155.02.414	26
111.95.360	31	117.64.616	23	134.45.330	24	155.00.787	22	155.02.415	26
111.95.361	31	117.64.626	23	134.45.430	24	155.00.789	22	155.02.420	28
111.95.362	31	117.64.636	23	134.45.600	24	155.00.795	22	155.02.421	28
111.95.363	31	124.02.104	37	134.80.610	1	155.00.800	22	155.02.430	25
111.95.364	31	124.02.210	38	134.80.629	1	155.00.801	27	155.99.000	27
111.95.365	31	124.02.220	38	134.88.610	20	155.00.880	24	155.99.001	26
115.61.601	49	124.02.244	37	136.94.330	14	155.00.881	24	155.99.002	27
115.61.602	49	124.02.310	38	151.00.311	47	155.00.960	45	155.99.003	28
115.61.603	49	124.02.320	38	151.00.320	47	155.00.961	45	155.99.004	28
115.61.604	49	124.02.330	39	151.09.609	47	155.00.962	45	155.99.005	28
115.61.607	49	124.02.332	39	151.33.203	23	155.00.963	45	155.99.006	26
115.70.008	46	124.02.344	37	151.35.208	48	155.00.964	45	155.99.007	27
115.70.009	46	124.02.430	39	151.35.262	48	155.00.965	45	155.99.008	27
115.70.010	46	124.02.432	39	151.35.665	48	155.00.966	45	155.99.009	28
116.07.219	29	124.02.444	37	151.50.215	48	155.00.980	18	155.99.010	26
116.07.221	29	124.02.500	39	151.90.352	17	155.00.981	18	155.99.011	27
116.07.228	29	124.02.501	39	151.90.353	17	155.00.982	18	155.99.012	27
116.07.229	29	124.02.502	37	151.90.354	17	155.00.983	18	155.99.013	28
116.07.238	29	124.02.910	38	151.90.355	17	155.01.150	35	155.99.014	28
116.07.240	29	124.02.911	38	155.00.040	7	155.01.280	20	155.99.015	26
116.07.318	30	124.02.920	38	155.00.041	7	155.01.281	20	155.99.016	27
116.07.319	30	124.02.921	38	155.00.060	8	155.01.283	20	155.99.017	27
116.07.321	30	124.02.974	37	155.00.061	8	155.01.284	20	155.99.018	25
116.07.329	30	124.02.984	37	155.00.071	7	155.01.285	20	155.99.019	25
116.07.338	30	125.68.051	15	155.00.072	7	155.01.545	47	155.99.020	25
116.07.339	30	125.68.052	15	155.00.073	9	155.01.546	47	155.99.021	25
116.07.413	30	125.68.351	15	155.00.074	9	155.01.610	7	155.99.022	25
116.07.419	29	125.68.352	15	155.00.091	8	155.01.611	7	155.99.023	25
116.07.421	30	126.14.901	34	155.00.092	8	155.01.612	7	155.99.024	25
116.07.429	29	126.15.900	34	155.00.093	9	155.01.613	7	155.99.025	25
116.07.438	29	126.22.036	34	155.00.094	9	155.01.620	8	155.99.026	25
116.07.439	30	126.22.909	34	155.00.440	24	155.01.621	8	155.99.027	25
116.07.611	29	126.27.036	35	155.00.441	24	155.01.622	8	155.99.028	16
116.07.619	30	126.27.306	35	155.00.540	48	155.01.623	8	155.99.029	16
116.07.621	29	126.27.310	35	155.00.545	48	155.01.668	27	155.99.030	16
116.07.628	30	131.20.002	5	155.00.600	24	155.01.669	27	155.99.031	16
116.07.632	29	131.20.120	5	155.00.601	24	155.01.818	16	155.99.032	25
116.07.639	30	131.20.220	5	155.00.696	26	155.01.819	16	792.01.060	34
117.05.600	19	131.33.700	22	155.00.697	26	155.01.825	9		
117.05.610	19	133.79.051	15	155.00.721	27	155.01.826	9		
117.05.620	19	133.79.351	15	155.00.751	28	155.02.291	9		
117.05.630	19	134.06.311	16	155.00.764	28	155.02.292	9		
117.05.640	19	134.06.441	16	155.00.765	28	155.02.410	26		



## THE CORNERSTONE COLLECTION

Just as the cornerstone is recognized as the builder's pivotal stone, our redesigned Cornerstone Collection for our customers is the pivotal collection designed for easy selection, and wide availability.

The collection includes:

- The curated Cornerstone collection
- Our best pricing
- Cornerstone Brochure, a brochure dedicated exclusively to the beautifully designed Cornerstone collection

# HÄFELE

HAF-COR-92022

**Häfele America Co.** | 3901 Cheyenne Drive | Archdale, NC 27263

**Phone:** 800 423 3531 | **Fax:** 800 325 6197 | **Showrooms:** New York, Archdale, Los Angeles

**hafele.com**

© & TM Häfele GmbH & Co KG and/or Häfele America Co. Other trademarks referenced are owned by their respective owners. All rights reserved. Materials, designs and design elements shown herein may be the subject of US and International copyright and other forms of legal protection.